



## #F1802 Installation Instructions 2011-2016 Ford Super Duty F250/350 4WD 8" Suspension Lift

### Read and understand all instructions and warnings prior to installation of product and operation of vehicle.

Zone Offroad Products recommends this system be installed by a professional technician. In addition to these instructions, professional knowledge of disassembly/ reassembly procedures and post installation checks must be known. Minimum tool requirements include the following: Assorted metric and standard wrenches, hammer, hydraulic floor jack and a set of jack stands. See the "Special Tools Required" section for additional tools needed to complete this installation properly and safely.

#### » PRODUCT SAFETY WARNING

Certain Zone Suspension Products are intended to improve off-road performance. Modifying your vehicle for off-road use may result in the vehicle handling differently than a factory equipped vehicle. Extreme care must be used to prevent loss of control or vehicle rollover. Failure to drive your modified vehicle safely may result in serious injury or death. Zone Offroad Products does not recommend the combined use of suspension lifts, body lifts, or other lifting devices.

You should never operate your modified vehicle under the influence of alcohol or drugs. Always drive your modified vehicle at reduced speeds to ensure your ability to control your vehicle under all driving conditions. Always wear your seat belt.

#### » TECHNICAL SUPPORT

[www.zoneoffroad.com](http://www.zoneoffroad.com) may have additional information about this product including the latest instructions, videos, photos, etc.

Send an e-mail to [tech-zone@ridefox.com](mailto:tech-zone@ridefox.com) detailing your issue for a quick response.

**888.998.ZONE** Call to speak directly with Zone tech support.

#### » PRE-INSTALLATION NOTES

1. Special literature required: OE Service Manual for model/year of vehicle. Refer to manual for proper disassembly/reassembly procedures of OE and related components.
2. Adhere to recommendations when replacement fasteners, retainers and keepers are called out in the OE manual.
3. Larger rim and tire combinations may increase leverage on suspension, steering, and related components. When selecting combinations larger than OE, consider the additional stress you could be inducing on the OE and related components.
4. Post suspension system vehicles may experience drive line vibrations. Angles may require tuning, slider on shaft may require replacement, shafts may need to be lengthened or trued, and U-joints may need to be replaced.
5. Secure and properly block vehicle prior to installation of Zone Offroad Products. Always wear safety glasses when using power tools.
6. If installation is to be performed without a hoist, Zone Offroad Products recommends rear alterations first.
7. Due to payload options and initial ride height variances, the amount of lift is a base figure. Final ride height dimensions may vary in accordance to original vehicle attitude. Always measure the attitude prior to beginning installation.

#### Difficulty Level

easy 1 2 **3** 4 5 difficult

Estimated installation: 8 hours

#### Special Tools Required

30mm (1-3/16") Sockets

46mm (1-13/16") Socket

Pitman Arm Puller

SPC #77880 (Cam Puller)

Heavy Duty Floor Jack and Stands

#### Tire/Wheel Fitment

Tire:

38 x 15.50\*

\*Minor trimming and/or bumper spacers may be required

Wheel:

17x9, 18x9, 20x9, 20 x10, 4.5" backspacing

## Kit Contents

### F3801 or F3802 Box Kit

Qty	Part
2	Front Coil Spring

### F1801 Drop Bracket Box Kit

Qty	Part
1	Driver Side Drop Bracket
1	Passenger Side Drop Bracket
4	1/4" Spacer
1	Bolt Pack – Drop Bracket
	4 3/4"-10 x 5" bolt
	4 3/4"-10 prevailing torque nut
	8 3/4" SAE washer
1	Bolt Pack – Drop Bracket
	8 1/2"-13 x 1-1/2" bolt
	8 1/2"-13 prevailing torque nut
	16 1/2" SAE washer

### F1802 Front Box Kit

Qty	Part
1	Stabilizer Bracket
1	Pitman Arm
1	Track Bar Bracket
1	Sway Bar Drop – DS
1	Sway Bar Drop – PS
2	Bump Stop Extension
1	3/4" Spacer
1	Bolt Pack - Stabilizer
	2 1/2"-13 x 1-1/4" bolt
	2 1/2"-13 prevailing torque nut
	6 1/2" SAE flat washer
	1 12mm-1.75 x 80mm bolt
	1 12mm-1.75 prevailing torque nut
2	Alignment Cam
2	Track Bar Cam Washer
1	Track Bar Bracket Spacer Plate

1	Bolt Pack – Sway Bar
	4 3/8"-16 x 1-1/4" bolt
	4 3/8"-16 prevailing torque nut
	8 3/8" USS flat washer
1	Bolt Pack – Bump Stop
	4 5/16"-18 x 1-1/4" bolt
	4 5/16"-18 prevailing torque nut
	8 5/16" SAE washer
	2 1/4"-20 x 3/4" bolt
	2 1/4"-20 prevailing torque nut
	4 1/4" SAE washer
	2 Clamp
1	Brake Line Bracket - DS
1	Brake Line Bracket - PS
1	Bolt Pack – ABS Line & Cotter Pin
	1 1/8" x 1" cotter pin clear zinc
	2 1/4"-20 x 3/4" self-tapping bolt
	2 Wire Clip
2	Zip Tie
2	Zip Tie Mountable
1	Loctite

### F1619 or F1618 Rear Box Kit

Qty	Part
1	Rear Brake Line Bracket
2	6" Rear Block
2	Spring Plate
4	3/4" U-Bolts
8	3/4" Flange Lock Nuts

### F6209 Add-a-Leaf Box Kit

Qty	Part
2	Short Add-a-Leaf
2	Long Add-a-Leaf
2	Center Pin
2	Leaf Spring Clamp

## Important—measure before starting!

Measure from the center of the wheel up to the bottom edge of the wheel opening

LF \_\_\_\_\_ RF \_\_\_\_\_

LR \_\_\_\_\_ RR \_\_\_\_\_

## INSTALLATION INSTRUCTION

### »» PRE-INSTALLATION NOTES

1. These vehicles, especially diesel models, are very heavy. Be sure that proper jacks/stands are used that are rated to handle the weight of the vehicle. Ensure that the vehicle is well supported before beginning the installation.
2. The factory front track bar bolt requires 405 ft-lbs of torque to be installed properly. Be sure you have the means of removing and installing this hardware properly. It is possible to install the hardware and torque to a more modest range (200 ft-lbs or so) and take the vehicle to a shop with the means to torque the hardware properly immediately after the installation is complete.

3. As a result of the location of the long radius arm suspension, support locations are limited. Use your best judgment while supporting the vehicle with sufficient strength stands at appropriate locations. The radius arms will need to move freely during this installation.
4. Exhaust modification may be required to clear front driveshaft (Gas Model Only)

---

## » FRONT INSTALLATION

1. Park the vehicle on a clean, flat surface and block the rear wheels for safety.
2. Disconnect the front track bar from the driver's side frame mount. **Figure 1** Save hardware.

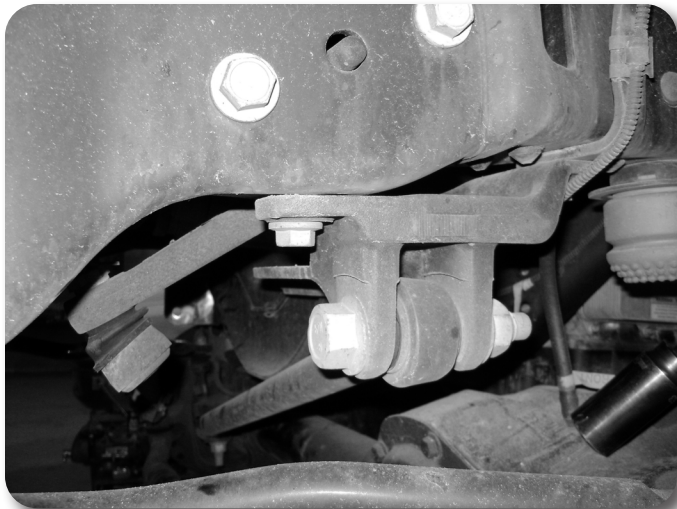

Figure 1

3. Raise the front of the vehicle and proper support with jack stands under the frame rails. Remove the front wheels.
4. Remove the front wheels.
5. Support the front axle with a hydraulic jack.
6. Disconnect the front brake line brackets from the axle. **Figure 2.** Save hardware.



Figure 2

7. The brake line axle bracket will need to be trimmed. Cut the brake bracket near the rolled end holding the OE brake line. **Figure 3** Drill a 1/4" mounting hole about 3/8" in from the cut edge and centered along the edge. Set the brackets aside to be reinstalled later.

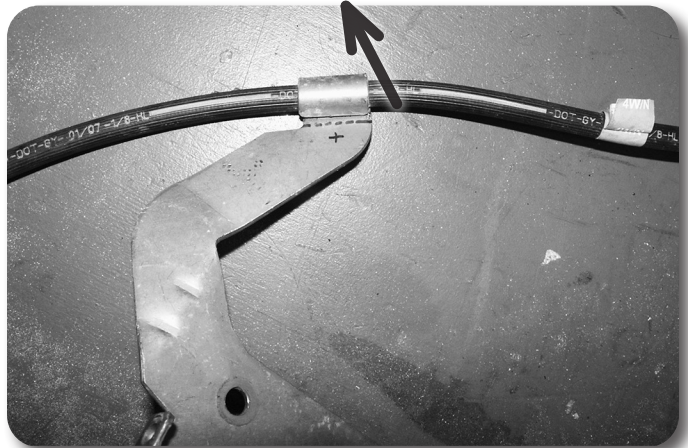

Figure 3

8. Remove the clips holding the front brake lines to the brackets on the frame. **Figure 4A** Using a proper line wrench, break loose the hard line at the junction block and rotate it 180 degrees. **Figure 4B** This will put the rubber line to the bottom. Tighten the hard line securely. Leave the brake line loose and save the retaining clip.

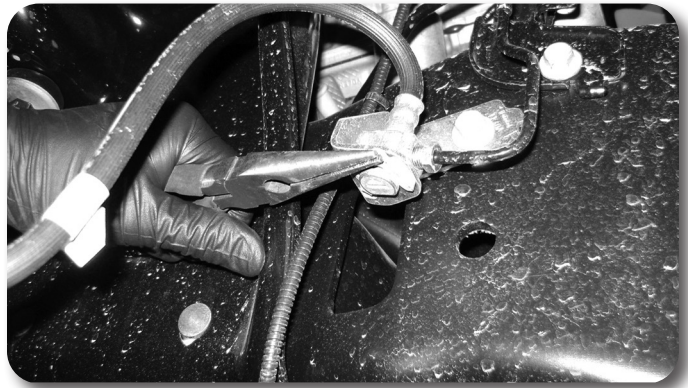

Figure 4A

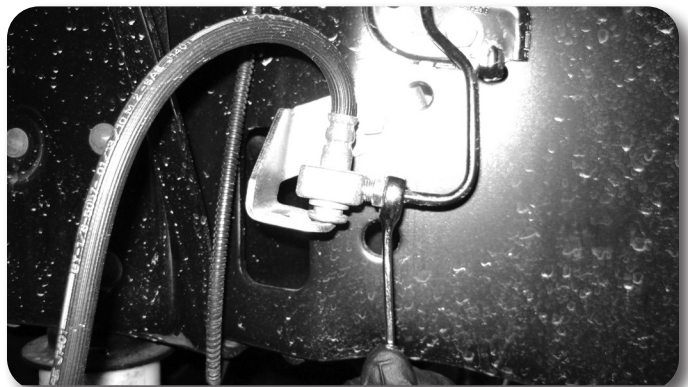

Figure 4B

9. Remove the front axle hub vacuum lines retaining clips from the axle/radius arm. **Figure 5A,B**



Figure 5A



Figure 5B

10. Remove the ABS brake lines from the retaining tabs on the radius arms. **Figure 6A** Carefully pull the plastic retaining clip free from the front of the radius arm. Remove the plastic tab from the rear portion of the arm. **Figure 6B** It will not be reused.

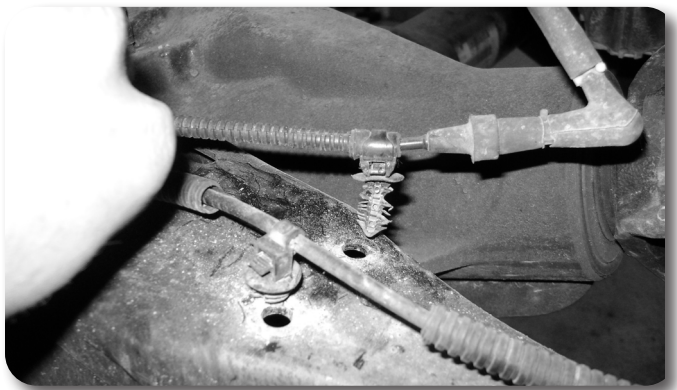

Figure 6A

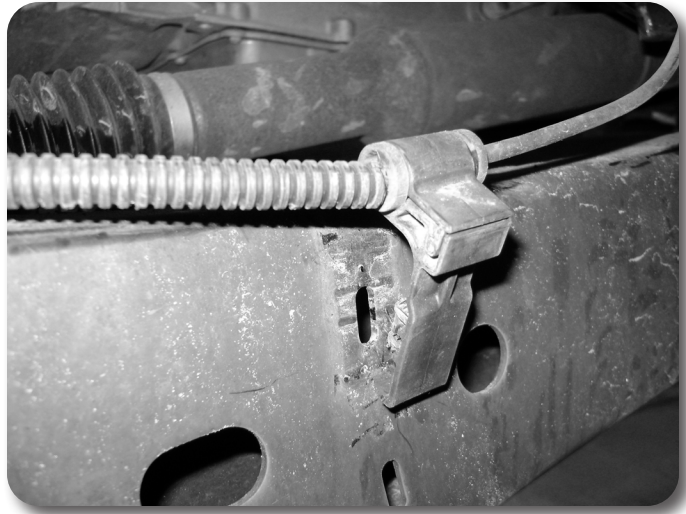

Figure 6B

### Step 12 Note

Steering Stabilizer hardware is located in Bolt Pack #657

11. Disconnect the OE steering stabilizer from the mount on the passenger's frame rail. Remove the factory frame mount, it will not be reused.
12. Install the new stabilizer frame bracket to the back side of the frame crossmember using the 2 front holes towards the passenger side. Use the provided 1/2" x 1-1/4" bolts, nuts, and washers and torque to 55 ft-lbs. **Figure 7A,B**

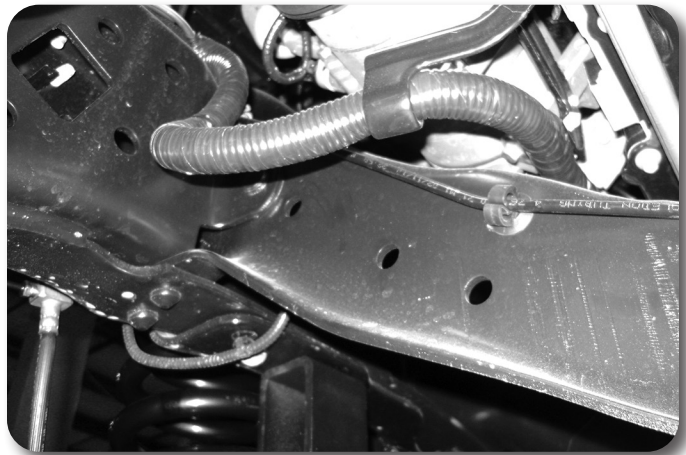

Figure 7A



Figure 7B

13. Disconnect the sway bar end links from the sway bar. Save hardware.
14. Disconnect the (5) bolts mounting the OE track bar bracket to the frame. **Figure 8** Remove bracket and save hardware.

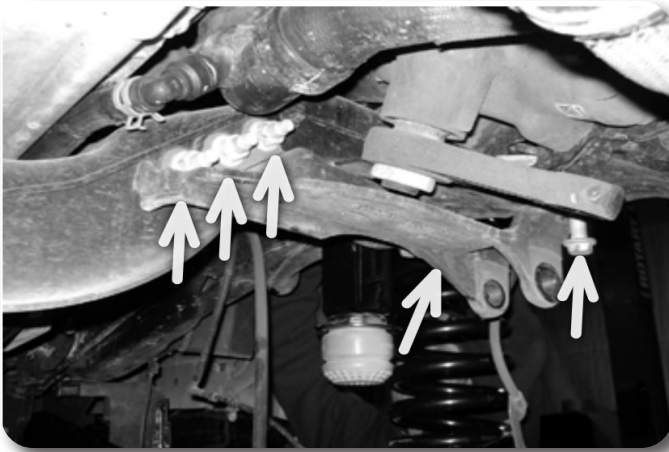

Figure 8

15. Disconnect the steering drag link from the pitman arm. Remove the cotter pin and castellated nut cap. Remove the nut and thread back on by hand a couple turns. Strike the end of the pitman arm near the drag link end to dislodge the taper from the pitman arm. **Figure 9** Remove the nut and the drag link from the pitman arm. Save all hardware.

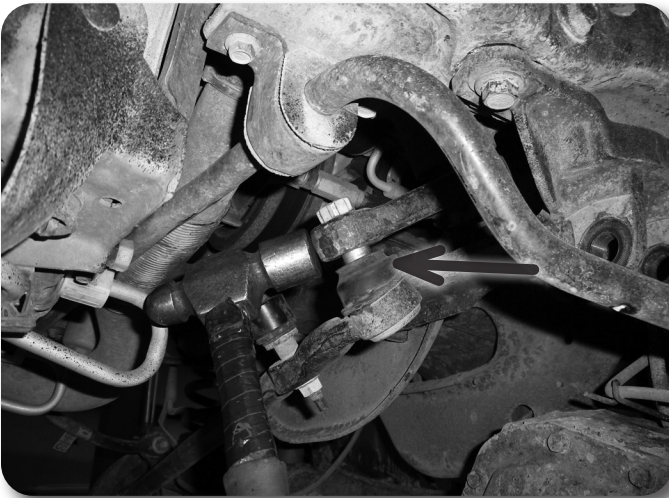

Figure 9

16. Remove the pitman arm nut. Note the indexing of the pitman arm in relation to the steering sector shaft and remove the pitman arm from the steering box using the appropriate puller.
17. Remove all of the dri-lock compound on the threads of the OE nut and steering sector shafts. This is important to ensure that the new thread lock compound will adhere properly.
18. Apply a bead of the supplied thread lock all the way around the threads of the OE nut and install the new pitman arm (indexed the same as the OE) and fasten with the OE nut. Torque the nut to 350 ft-lbs.
19. Install the new track bar bracket using the stock mounting hardware as it was removed. Place the provided 3-hole spacer plate between the new bracket and the frame crossmember. Torque all (5) mounting bolts to 129 ft-lbs. Do not

install track bar at this time, it will be installed once the vehicle is on the ground.  
Figure 10A,B



Figure 10A (From Front)

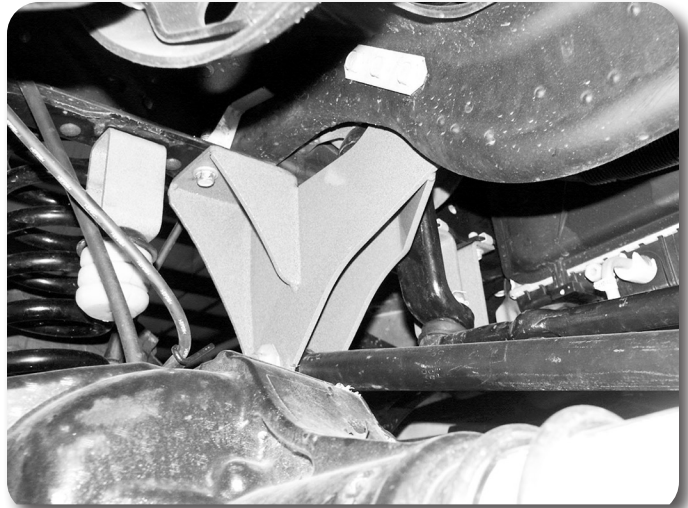

Figure 10B (From Rear)

20. With the axle still well supported with a jack, disconnect the front shocks from the axle mounts. Leave the shocks attached to the frame, they will be used for added axle support during the next portion of the installation. Save axle hardware.
21. Carefully lower the axle and remove the factory front springs. Take care not to over-extend any lines/hoses. Save the upper spring isolator to be reinstalled with the new springs.
22. Reconnect the shocks to the axle with the original hardware. The shocks will help support the axle during the radius arm bracket installation.
23. Remove the factory bump stops from the retainer cups on the frame.  
**Figure 11A** Remove the bolt holding the retainer cup to the frame and remove from vehicle.





Figure 11A



Figure 11B

24. Position the cup on the provided bump stop extension. The alignment tab on the bump stop cup will fit in the second hole in the extension.
25. Install the cup on the provided bump stop extension with a 5/16" x 1-1/4" bolt, nut and 5/16" SAE washers from hardware pack #435. The alignment tab on the bump stop cup will fit in the second hole in the extension. Torque hardware to 20 ft-lbs.
26. Install the extended bump stop to the frame with the original hardware and a 5/16" x 1-1/4" bolt, nut and 5/16" SAE washers. The 5/16" hardware will go in one of the two remaining bracket mounting holes that line up to an existing frame hole. Torque hardware to 20 ft-lbs. The closed face of the extension should face the outside of the vehicle. Install the original bump stop in the relocated bump stop cup. NOTE: If there is not a second existing hole in the frame, mark one of the holes and drill a 5/16" hole in the frame. Take care to check the area before drilling.
27. Loosen the 4 radius arm mounting bolts at the axle. Figure 12 Once again make sure that the axle is well supported by a jack.

### Step 26 Note

Bump Stop Extension hardware is located in Bolt Pack #435

### Step 27 Note

On some models, the driver's side upper nut is welded to the radius arm.



Figure 12

28. Starting with the passenger's side, 1st remove the upper radius arm mounting bolt at the axle. 2nd, remove the radius arm bolt at the frame and lower the radius arm from the frame bracket. 3rd, remove the lower mounting bolt at the axle and remove the radius arm from the vehicle. **Figure 12 & 13** Save hardware.



Figure 13

### Step 29 Note

Radius arm bracket hardware is located in hardware pack #430 and #958. The new bolts will fit tight in the factory bracket. Installing them simultaneously will help to align the bracket holes. In some cases, because of varying tolerance the front factory bracket hole may need to be clearanced slightly.

29. Install the new provided radius arm bracket into the factory frame bracket. The brackets are side specific. Install radius arm brackets with the Zone "Z" facing outwards. Align the hole in the bracket with the factory mount holes and install the two 3/4" x 5" bolts, nuts and washers in the holes. **Figure 14** Do not tighten the 3/4" hardware at this time.



Figure 14

30. Mark the location of the four 1/2" holes at the back of the radius arm brackets. Drill all the holes out to 9/16". Install the 1/2" x 1-1/2" bolts, nuts and washers in the holes. **Figure 15A** The 1/4" Spacers will be used on the outside of the frame sandwiched between radius arm bracket and the frame. **Figure 15B** With all bolts installed, starting with the 1/2" hardware on the bottom of the frame torque to 60 ft-lbs, next torque the 1/2" hardware on the outside of the frame to 60 ft-lbs, and finally torque the 3/4" hardware to 250 ft-lbs.

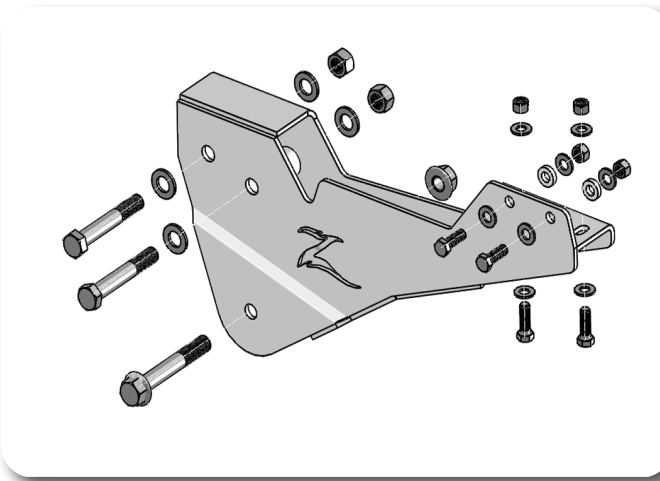

Figure 15A

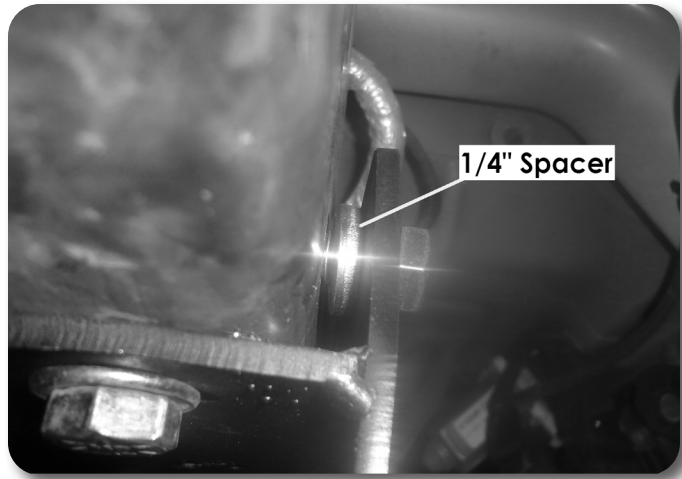

Figure 15B

31. Swing the passenger's side radius arm up into the new bracket and fasten with the factory hardware. Leave hardware loose.
32. Repeat the bracket installation on the driver's side.
33. With both brackets installed, reattach the upper radius arm mount to the axle with the factory hardware. Leave hardware loose. All (6) radius arm hardware will be tightened with the weight of the vehicle on the suspension.
34. With the axle still well supported, disconnect the shocks from the axle and frame. Save the axle mount hardware.
35. Lower the axle just enough to install the new coil springs along with the factory upper rubber isolator. Once installed, rotate the coil so it seats properly in the axle mount. Raise the axle until the coil is seated in the upper mount.
36. Locate the new front shocks, bushings and sleeves. Install the bushings and sleeves into the shock eyes. Install the shocks using the factory lower hardware and provided stem hardware.
37. Torque shock hardware at axle to 100 ft-lbs. Tighten stem hardware until bushings deform.
38. Note the orientation of the front sway bar (top versus bottom). Disconnect the sway bar from the frame and remove from the vehicle. Retain hardware.
39. Install the provided sway bar drop bracket to the original sway bar frame mounting locations with the original hardware. Mount the drop bracket with the open face toward the inside of the vehicle and the bracket offset toward the front. Torque hardware to 30 ft-lbs.
40. Attach the sway bar to the new drop brackets in the correct orientation with the 3/8" hardware. Torque hardware to 30 ft-lbs. **Figure 16**

### Step 36 Note

The suspension will have to be compressed slightly to attach the shocks.

### Step 40 Note

Sway bar drop bracket hardware is located in hardware pack #422.

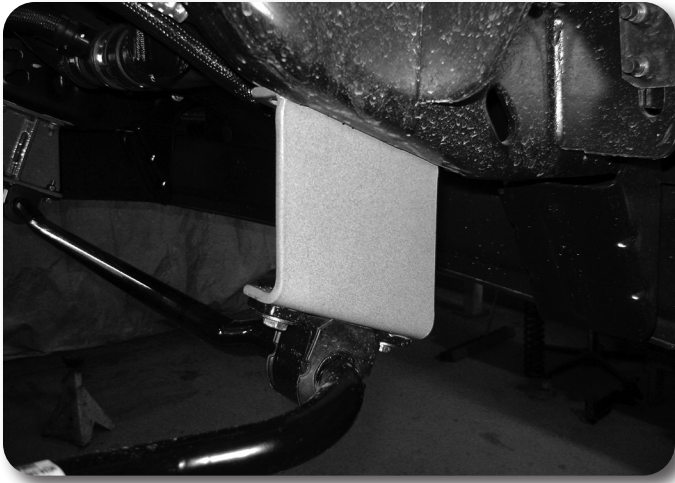

Figure 16

41. Install the sway bar link ends to the sway bar and secure with the OE hardware. Torque to 90 ft-lbs.
42. The ABS lines need to be rerouted along the frame. Make a mark on the frame approximately 1-1/2" behind the coil bucket and 1-1/2" from the bottom of the frame. Drill a 7/32" hole at the mark. Drill a second 7/32" hole in the inner fender liner, straight back from the first hole location. **Figure 17A,B**



Figure 17A



Figure 17B

## Step 42,43 Note

All ABS line bracket hardware is located in hardware pack #656.

43. Locate the provided wire clamps, 1/4" self-tapping bolts and mountable zip ties (tree on the end). With the suspension at full extension (hanging from shocks) ensure that the ABS line still has some slack from the new mounting point on the frame to the axle. Fasten the line to the frame with the wire clamp and 1/4" self-tapping bolt. Figure 17B Attach the loose end inside the inner fender with the mountable zip tie. Note: The rubber collar on the ABS line can be slid on the line using a little silicone spray.
44. Reattach all vacuum lines. Use the provided zip ties where needed.
45. Remove the factory front upper brake line brackets from the frame. Locate and install the provided drop brake line brackets with the factory hardware so the bracket offsets towards the rear. Carefully reform the hard line and attach the junction block through the bottom of the new bracket with the factory retaining clip. Figure 18

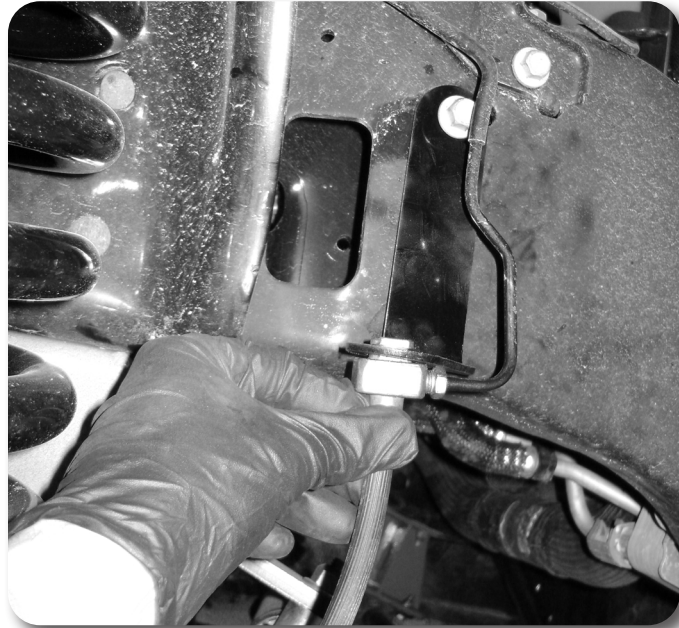

Figure 18

46. At the axle, attach the brake line to the bracket with a provided clamp, 1/4" x 3/4" bolt, nut and washers in hardware pack #435 using the hole drilled earlier. Torque bolt to 10 ft-lbs. Ensure adequate slack is given to the brake line at full droop of the suspension. Adjust the position of the clamp accordingly. Figure 19

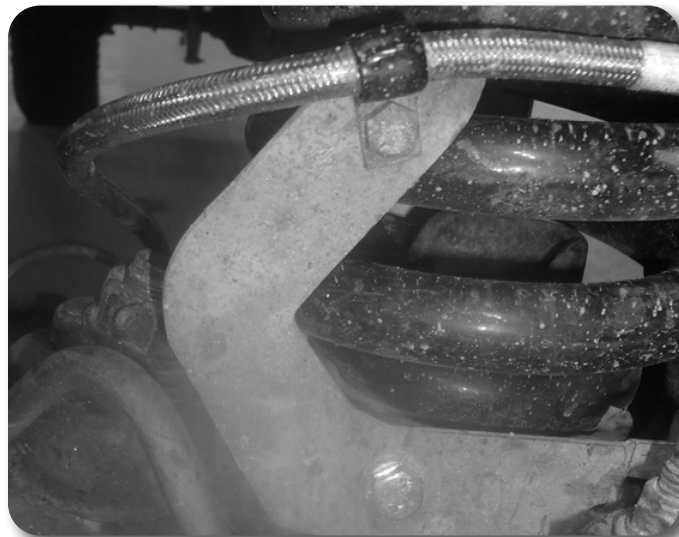

Figure 19

47. Properly bleed the brake system of air and top off the brake fluid reservoir with the proper type of fluid (see owners manual).
48. Reattach the steering drag link to the pitman arm. Torque nut to 148 ft-lbs. Install the original castellated nut cap and new 1/8" cotter pin.
49. Install the factory steering stabilizer below the new frame mount with the 12mm hardware and 3/4" steel spacer. Torque hardware to 55 ft-lbs. **Figure 20**



Figure 20

50. Check front driveshaft for binding. In some cases the u-joints may max out and require a replacement driveshaft.

## » ALIGNMENT CAM INSTALLATION

51. Remove the cotter pin from the upper ball joint. **Figure A**



Cam Install Figure A

52. Loosen the upper ball joint stud until the nut is level with the top of the stud. Strike the axle "ear" near the upper ball joint to release the ball joint to sleeve taper.
53. Remove the OE ball joint sleeve from the axle using the appropriate removal tool (SPC #77880 or equivalent). **Figure B**

### Step 48 Note

New cotter pin is located in hardware pack #656.

### Step 49 Note

Hardware for the steering stabilizer bracket is located in hardware pack 657.

### Step 52 Note

The top of the stud can also be struck using a soft blow hammer to aid in loosening the taper. Take care not to damage the stud/nut threads.



Figure B

54. Install the new sleeve with the arrow on the top of the sleeve pointing toward the front of the vehicle. 2 different sleeves are included. The sleeve marked “2.3 degrees” should be used on the driver’s side and the sleeve marked 2.6 degrees should be used on the passenger’s side. Using the old sleeve, pound down on the new sleeve to seat it on the ball joint taper. Make sure that the flat of the sleeve is flush with the flat of the axle. Figure C



Figure C

55. Install and torque the OE ball joint nut to 69 ft-lbs. Install the cotter pin. Note: Do not loosen the nut to install the cotter pin.



Figure D

56. Install the front wheels and lower the vehicle to the ground. Torque lug nuts to 165 ft-lbs.
57. Bounce the front of the vehicle to settle the suspension. Torque all factory radius arm hardware to 220 ft-lbs.



a heavy rubber dead-blow rubber hammer to help align the end into the bracket.

58. Attach the track bar to the new bracket with the OE hardware. Turn the steering wheel to aid in aligning the track bar in the bracket. Install the provided cam washers between the alignment tabs on the bracket. The cam washers have an offset hole. Position the cam washer in the position that best centers the axle under the vehicle. Fasten with the OE bolt and nut. Torque hardware to 405 ft-lbs. **Figure 24**



Figure 24

59. Check all hardware for proper torque.

---

## » REAR INSTALLATION

1. Block the front wheels for safety.
2. Raise the rear of the vehicle and support with jack stands under the frame rails just ahead of the spring hangers.
3. Remove the wheels.
4. Support the axle with a hydraulic jack.
5. Remove the ABS wires from the axle bracket. Remove the brake line retaining clips. Remove the brake lines from the factory axle bracket. This can be done by pulling the lines through the bracket and carefully cutting slots in the factory bracket to allow the lines to be removed. The new brake line relocation bracket has these slots.
6. Remove the factory brake line bracket from the axle by removing the breather tube stud. Discard the bracket, but save the breather tube stud.
7. Remove the factory shocks. Save all mounting hardware.
8. Disconnect the passenger's side spring u-bolts. Using two C-Clamps, clamp the leaf spring on each side of the top u-bolt plate. Remove the center pin nut and remove the u-bolt plate. **Figure 25**

### Step 9 Note

The factory rear block will vary depending on the vehicle model. F-250s will have a 1-7/8" block and F-350s will have a 3-3/4" block. In both cases, replacing the factory block with the new provided block will net the same level stance regardless of vehicle model.



Figure 25

9. Lower the axle and remove the factory lift block. It will not be reused.
10. Cut off the front leaf alignment clamp for clearance w/ the new add-a-leafs.
11. Locate the supplied dual add-a-leafs and reassemble the leaf pack with the new add-a-leafs in place. The leaf pack should be assembled as a pyramid with the longest leaf on top to the shortest leaf on the bottom. Reinstall the center pin nut and torque to 40 ft-lbs. Figure 26 The u-bolts, top plate and bottom plate will not be reused.

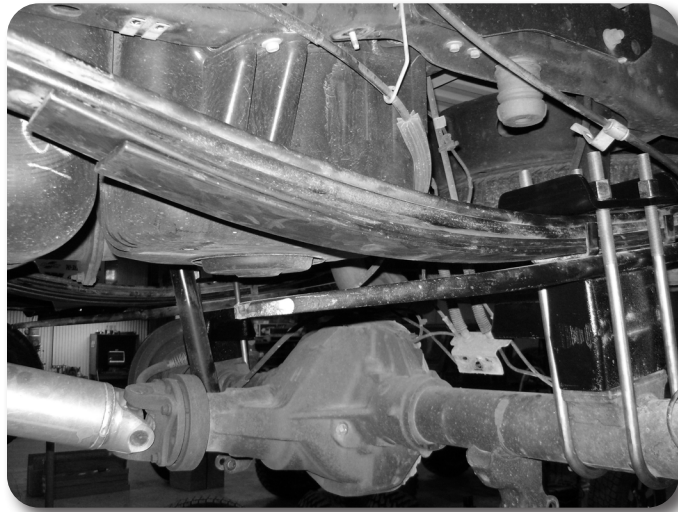

Figure 26

12. Remove the C-clamps from the leaf pack and ensure the individual leafs are all inline with each other. Install the provided bend-over style clamps on the front of the new leaf pack. Bend the ends of the clamps over to secure them to the spring.
13. Models equipped with overload leafs will need the separation block modified. Trim the rotation tabs from the front side of block on both the inside and outside of the block. Use extreme care near the fuel tank, do not use any method that will create sparks if the block is not removed when modified. A sawzall is highly recommended. Figure 27

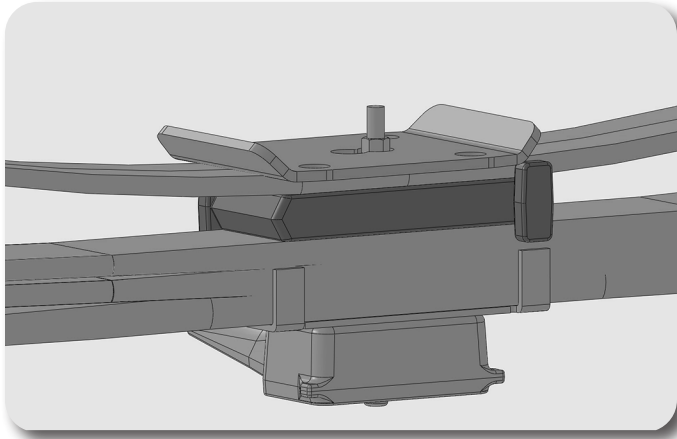

Figure 27

14. Lower the axle enough to place the provided 6" lift block between the axle and the leaf spring. Take care not to over extend the brake lines. Make note that there are two center pin holes in the new blocks. The center pin will need to be aligned to the rear hole. This will ensure the axle moves slightly forward and the wheels are aligned properly in the wheel well.
15. Raise the axle to engage the block spring alignment pins. Be certain the leaf center pin aligns with the REAR hole in the new lift block. Position the new u-bolt plate on the top of the spring over the center pin nut. Position the plate so the bolt pattern is shifted forward on the spring. **Figure 28** Fasten the entire assembly with the provided u-bolts, high nuts and washers. Snug but do not torque the u-bolts at this time



Figure 28

16. Repeat add-a-leaf and block installation of the driver's side. Note: The parking brake cable bracket will need to be removed from the spring center pin. **Figure 29**



Figure 29

17. If more parking brake cable slack is needed, remove the cable from the rear most retaining bracket on the frame. **Figure 30**



Figure 30

18. Install the rear brake line relocation bracket to the factory axle with the factory breather tube stud. Attach the breather tube and attach the brake lines to the relocation bracket using the OE brake clips. **Figure 31**

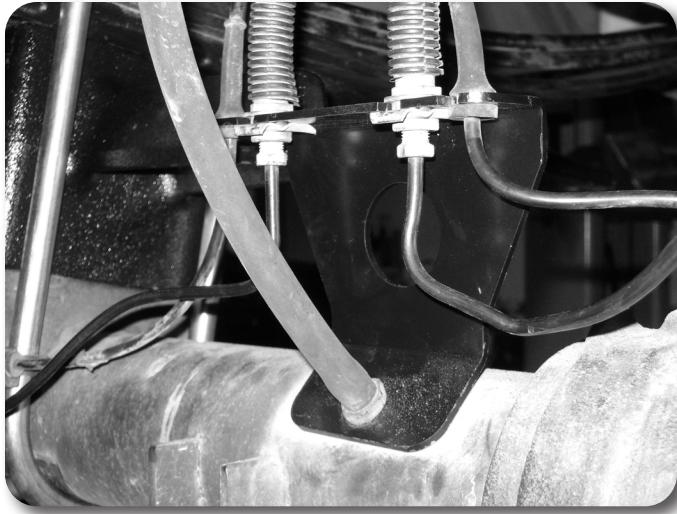

Figure 31

19. Install the new shocks with the original mounting hardware.
20. Install wheels and lower the vehicle to the ground.
21. With the weight of the vehicle on the axle, torque the u-bolts to 130-150 ft-lbs.

## »» **POST INSTALLATION**

1. Check all hardware for proper torque. Check hardware after 500 miles.
2. Be sure the brake system has been properly bled and the brake fluid is topped off.
3. The steering wheel will need to be re-centered. This is done by adjusting the drag link collar near the passenger's side steering knuckle. Torque clamps to 41 ft-lbs. Thread the collar to lengthen the drag link.
4. Adjust headlights.

## **Post-Installation Warnings**

1. Check all fasteners for proper torque. Check to ensure for adequate clearance between all rotating, mobile, fixed, and heated members. Verify clearance between exhaust and brake lines, fuel lines, fuel tank, floor boards and wiring harness. Check steering gear for clearance. Test and inspect brake system.
2. Perform steering sweep to ensure front brake hoses have adequate slack and do not contact any rotating, mobile or heated members. Inspect rear brake hoses at full extension for adequate slack. Failure to perform hose check/ replacement may result in component failure.
3. Perform head light check and adjustment.
4. Re-torque all fasteners after 500 miles. Always inspect fasteners and components during routine servicing.