



#J1405 Installation Instructions 1987-1995 Jeep Wrangler YJ 4" Suspension Lift

Read and understand all instructions and warnings prior to installation of product and operation of vehicle.

Zone Offroad Products recommends this system be installed by a professional technician. In addition to these instructions, professional knowledge of disassembly/ reassembly procedures and post installation checks must be known. Minimum tool requirements include the following: Assorted metric and standard wrenches, hammer, hydraulic floor jack and a set of jack stands. See the "Special Tools Required" section for additional tools needed to complete this installation properly and safely.

» PRODUCT SAFETY WARNING

Certain Zone Suspension Products are intended to improve off-road performance. Modifying your vehicle for off-road use may result in the vehicle handling differently than a factory equipped vehicle. Extreme care must be used to prevent loss of control or vehicle rollover. Failure to drive your modified vehicle safely may result in serious injury or death. Zone Offroad Products does not recommend the combined use of suspension lifts, body lifts, or other lifting devices.

You should never operate your modified vehicle under the influence of alcohol or drugs. Always drive your modified vehicle at reduced speeds to ensure your ability to control your vehicle under all driving conditions. Always wear your seat belt.

» TECHNICAL SUPPORT

www.zoneoffroad.com may have additional information about this product including the latest instructions, videos, photos, etc.

Send an e-mail to tech-zone@ridefox.com detailing your issue for a quick response.

888.998.ZONE Call to speak directly with Zone tech support.

» PRE-INSTALLATION NOTES

1. Special literature required: OE Service Manual for model/year of vehicle. Refer to manual for proper disassembly/reassembly procedures of OE and related components.
2. Adhere to recommendations when replacement fasteners, retainers and keepers are called out in the OE manual.
3. Larger rim and tire combinations may increase leverage on suspension, steering, and related components. When selecting combinations larger than OE, consider the additional stress you could be inducing on the OE and related components.
4. Post suspension system vehicles may experience drive line vibrations. Angles may require tuning, slider on shaft may require replacement, shafts may need to be lengthened or trued, and U-joints may need to be replaced.
5. Secure and properly block vehicle prior to installation of Zone Offroad Products. Always wear safety glasses when using power tools.
6. If installation is to be performed without a hoist, Zone Offroad Products recommends rear alterations first.
7. Due to payload options and initial ride height variances, the amount of lift is a base figure. Final ride height dimensions may vary in accordance to original vehicle attitude. Always measure the attitude prior to beginning installation.

Difficulty Level

easy 1 2 **3** 4 5 difficult

Estimated installation: 4-6 hours

Special Tools Required

T40, T55 Torx Drive Socket

1-5/16" Socket

Pitman Arm Puller

Pickle Fork/2-Jaw Puller

Tire/Wheel Fitment

Tire: 33x12.50

Wheel: 15x8 w/3.5-4" backspacing

***Important* Verify you have all of the kit components before beginning installation.**

Kit Contents

Qty	Part	Qty	Part
4	Leaf Spring	1	Pitman Arm - Power Steering Only
6	1/2" x 2-1/2" x 6-3/4" U-bolt/nuts/washers	1	Front Track Bar Relocation Bracket
2	1/2" x 3-1/4" x 7" U-bolt/nuts/washers	1	Bolt Pack - Front Track Bar
16	Leaf Spring Bushing	4	Bump Stop Extension
4	0.750 x 0.090 x 3.00 Sleeve	1	Rear Brake Line Bracket
4	0.750 x 0.120 x 3.00 Sleeve	2	3/8" Brake Line Bracket Hardware
2	4 Degree Leaf Spring Shim	3	1/8" Cotter Pin
2	5/16" x 3-1/2" Center Pin/Nut	2	Front Sway Bar Link w/Bushings
1	Front Brake Line Bracket (drv)	6	Transfer Case Drop Spacer
1	Front Bracket Line Bracket (pass)	6	Transfer Case Drop Tapered Spacer
2	5/16" Brake Line Hardware	6	1/2" x 3" Transfer Case Drop Bolt
		6	7/16" USS Flat Washer

Important—measure before starting!

Measure from the center of the wheel up to the bottom edge of the wheel opening

LF _____ RF _____

LR _____ RR _____

Step 5 Note

A T40 Torx drive will be needed to remove the factory bolt from the frame.

Pre-Installation Notes

1. When working on older model vehicles it is important to do a thorough check of all factory steering, brake and drivetrain components. Parts such as tie rod ends, brake lines and driveshaft u-joints should be inspected for wear and replaced if necessary.
2. The leaf springs provided in this lift system are based from the ride height of a new factory spring. Vehicles with high mileage and/or worn factory springs may net more than the 4" expected lift height.

Front Installation

1. Park vehicle on a clean, flat surface and block the rear wheels for safety.
2. Raise the front of the vehicle and support with jack stands under the frame rails directly behind the leaf spring hangers.
3. Remove the wheels.
4. Remove the factory front shocks. Save the lower hardware and discard the rest.
5. Locate the front brake line junctions mounted to the top of the frame rails, just ahead of the shock towers. **Figure 1** Remove the bolt mounting each junction (1 per side) to the frame. Save hardware.



Figure 1

6. Disconnect the front sway bar links from the leaf spring u-bolts plates **Figure 2**. Also disconnect the links from the sway bar. The sway bar hardware is tapered and will require a 2-jaw puller or pickle fork to remove. Save hardware.



Figure 2

7. Loosen but do not remove the front track bar bolt at the frame. Remove the track bar bolt from the axle mount. **Figure 3A,B** The frame hardware will require a T55 torx drive.



Figure 3A



Figure 3B

Step 9 Note

Provided pitman arm is for power steering equipped vehicles only

Step 11 Note

The shorter side of the spring has the part number painted on it and will mount to the spring hanger. The longer side of the springs will mount to the shackle.

8. Remove the cotter pin from the steering drag link tie rod end at the pitman arm. Remove the tie rod end nut and thread back on a couple turns. Strike the pitman arm at the tie rod end to dislodge the taper. Do not strike the tie rod end. Remove the nut and tie rod end from the pitman arm. Save nut.
9. Remove the pitman arm nut/washer from the sector shaft. Remove the pitman arm from the steering box using an appropriate pitman arm puller. Note the orientation of the pitman arm for reference when install new arm. Save hardware.
10. Install the new provided dropped pitman arm on the sector shaft in the same orientation as the original. Fasten with the factory nut and washer. Torque nut to 185 ft-lbs.
11. Locate the provided new leaf springs, bushings and sleeves. There are two different sized sleeves with IDs of 1/2" and 9/16". The 1/2" ID sleeves will mount to the shackle end of the spring and the 9/16" to the hanger end. The hanger end has the part number painted on it and is the shorter side. Lightly grease and install the bushings and sleeves into the spring ends. Assemble all 4 springs at this time.
12. Loosen but do not remove the leaf spring shackle and hanger bolts Figure 4A,B as well as all 4 front leaf spring u-bolts Figure 4C.

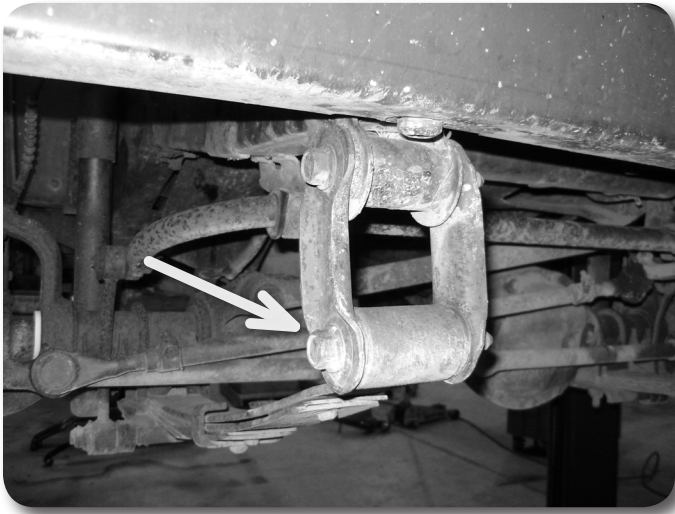

Figure 4A

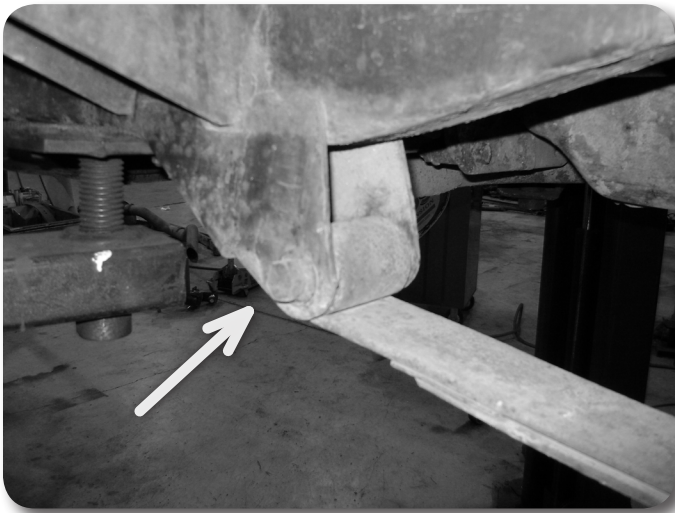

Figure 4B

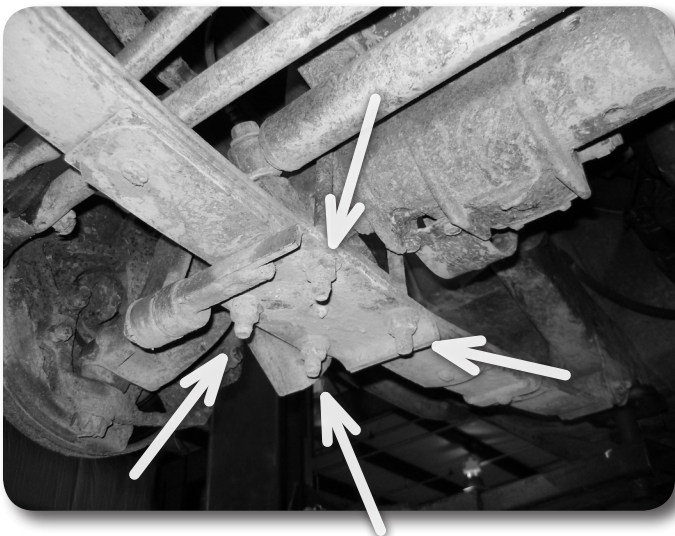

Figure 4C

Step 12 Note

When lowering the axle make sure not to over-extend the brake lines. They can be carefully pulled down from the top of the frame to gain needed slack.

13. Working on one side at a time, support the front axle with a hydraulic jack. Remove the leaf spring u-bolts followed by the leaf spring hanger/shackle bolts and remove the spring from the vehicle. Save leaf spring hardware.
14. Install the new leaf spring to the frame and shackle mounts using the factory hardware. Leave hardware loose.
15. Lower the axle to the leaf spring and align the center pin/hole. Fasten the leaf springs to the axle with the provided new u-bolts. Position the provided bump stop extension on top of the axle. They will be held in place with the outside u-bolt on each side. Use the provided wider u-bolts on the inside positions. Fasten with the provided ½" high nuts and washers. Snug hardware just enough to loosely seat the spring. Repeat spring installation on opposite side of the vehicle.
16. With the front spring installation complete, torque the u-bolts to 75-90 ft-lbs.
17. Locate the new provided sway bar links and bushings. Lightly grease and install the provided hourglass bushings in the sway bar links. Install the factory upper tapered sway bar link stud into one end of each link.
18. Attach the new sway bar links to the sway bar and factory u-bolt plate stud. Fasten with the factory nuts. Use the new provided cotter pins in the factory upper mount studs. Torque the link nuts to 45 ft-lbs.
19. Locate the provided brake line drop brackets. They are driver's/passenger's side specific. See **Figure 5** to identify the brackets. Attach the brackets to the original brake line junction location on the top of the frame rails with the original hardware. Torque bolts to 15-20 ft-lbs. The brackets should be oriented so they rest against the edge of the shock tower, pointing out toward the tire. **Figure 6**

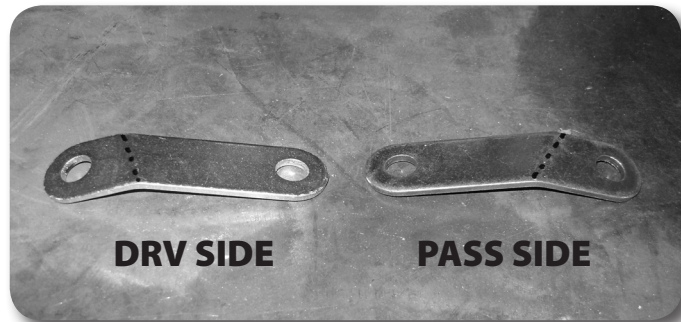

Figure 5



Figure 6

20. With the bracket line brackets installed, carefully reform the brake hard lines to attach the junction to the new brackets. Fasten the junction with the provided 5/16" hardware. Torque hardware to 15 ft-lbs.
21. Locate the new provided front track bar relocation bracket. Temporarily attach the new track bar bracket to the axle with the 12mm x 60mm bolt, nut and 7/16" USS washers provided. The offset in the plate will go up and the tab with a slotted hole will fit in between the casting webs.
22. Mark the location of the slotted hole using the bracket as a template.
23. Remove the bracket and drill a 7/16" hole at the mark through the track bar axle mount. It may be necessary to disconnect the steering stabilizer from the axle to allow for drill clearance.
24. Reattach the new bracket to the axle with the 12mm hardware. Also, attach the bracket through the newly drilled hole with a 7/16" x 1-1/4" bolt, nut and 7/16" SAE washer. Torque 7/16" hardware to 50 ft-lbs and 12mm hardware to 70 ft-lbs. Figure 7A/B



Figure 7A - Figure 1 from 124004

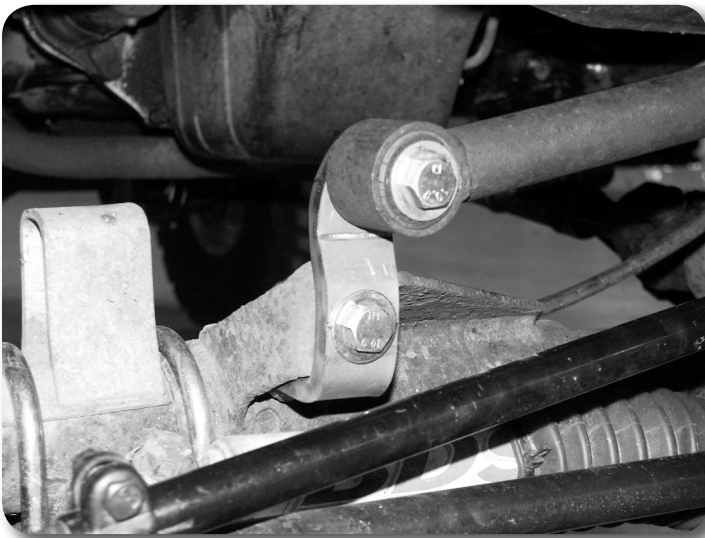

Figure 7B - Figure 2 from 124004

Step 25 & 26 Note

The hardware for the stem eliminator is in Bolt Pack 946 in the shock box kit.

25. Locate the new provided front shocks. Install the provided bushings and sleeves into the correct end of the shock. The narrower bushing and sleeve will install on the shaft end. Install the provided stem eliminator onto the bushings of the shaft end with the provided 1/2" hardware. Torque 1/2" hardware to 55 ft-lbs. Install the wider bushing and sleeve into the body end of the shock.
26. Install the shock onto the vehicle. The shaft end with the stem eliminator will go up towards the frame of the vehicle and install with the provided 3/4" nut and washer. The body end will install at the axle end with the factory hardware. Torque the lower hardware to 45 ft-lbs.
27. Install the wheels and lower the front of the vehicle to the ground. Bounce the front of the vehicle to help settle the suspension into place. Torque lug nuts to 75-90 ft-lbs.
28. Install the front track bar to the front face of the new bracket with the provided 12mm x 70mm bolt, nut and 7/16" USS flat washers. Torque hardware to 70 ft-lbs. Torque the track bar-to-frame mount bolt to 125 ft-lbs.
29. Retorque the leaf spring u-bolts to 90 ft-lbs.
30. Torque the leaf spring shackle bolts to 75 ft-lbs, hanger bolts to 90 ft-lbs.
31. Check brake line clearance to the tires. Reposition as necessary to ensure they do not rub throughout full steering sweep.
32. Check all hardware for proper torque.

Transfer Case Drop

1. Locate and loosen the 4 transmission mount nuts at the center of the transfer case skid plate.
2. Support the skid plate with an appropriate jack and loosen the 6 skid plate bolts (3 per side).
3. With all 6 bolts loose, remove the driver's side bolts. Lower the skid plate from the frame just enough to place the provided spacers between the frame and skid plate. The spacers are hollow on one side and are designed to fit over the raised portion of the frame with this hollow side up. Remove any rust so the spacers will sit flat against the frame.
4. Locate the provided new 1/2" x 3" bolts, tapered washers, and 7/16" USS washers. Apply a small amount of Loctite to the bolt threads and install through the skid plate and spacers into the frame. Leave loose.

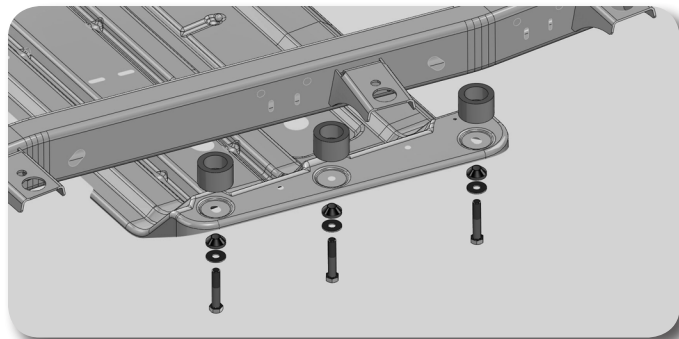

Figure 8

5. Repeat transfer case drop on the passenger's side. When all 6 bolts are install, torque to 60 ft-lbs.
6. Retighten the 4 transmission mount nuts to 20 ft-lbs.
7. Check for proper clearance between the transfer case and the skid plate.

Rear Installation

1. Block the front wheels for safety and raise the rear of the vehicle. Support with jack stands under the frame rails just ahead of the leaf spring hangers.
2. Remove the wheels.
3. Located the brake line junction on the driver's side frame rail. Remove the clip holding the line to the bracket and save. Carefully remove the line from the factory bracket and pull down on the line while reforming the hardline to gain approximately 3" of slack. The line will be attached to a relocation bracket later in the installation.
4. Remove the factory shocks from the axle and frame mounts. Save hardware.
5. Remove the rear track bar bolts at the frame and axle. Remove the track bar from the vehicle. It will not be reused.
6. Loosen but do not remove the leaf spring shackle and hanger bolts as well as all 4 rear leaf spring u-bolts.
7. Working on one side at a time, support the rear axle with a hydraulic jack. Remove the leaf spring u-bolts followed by the leaf spring hanger/shackle bolts and remove the spring from the vehicle. Save leaf spring hardware.
8. If installing this lift without any additional driveline modifications (ex: SYE/CV driveshaft, motor mount lift) then it is necessary to install the provided 4 degree shims on the rear leaf spring to correct the rear driveline angle. Additional shims may be necessary when using a combination of drivelines modifications. Using 2 c-clamps, clamp the leaf spring together on each side of the center pin. Remove the center pin from the spring. Place a provided shim on the top leaf and run a new center pin from the top down through the shim/spring. Fasten with the provided nut and tighten to 20 ft-lbs. The excess pin can be cut off. Before tightening the center pin, be sure the thick portion of the shim is toward the front end of the spring that has the larger 9/16" ID sleeve. This will ensure that the axle pinion is rotated up when the spring is installed. **Figure 9**

Step 4 Note

It is desirable to completely remove the rear track bar from the vehicle. Unlike the front track bar that aids in steering/handling, the rear track bar provides very little benefit to the overall function of the rear suspension. Removing the track bar actually frees up the rear suspension, in some cases allowing it to articulate more freely.

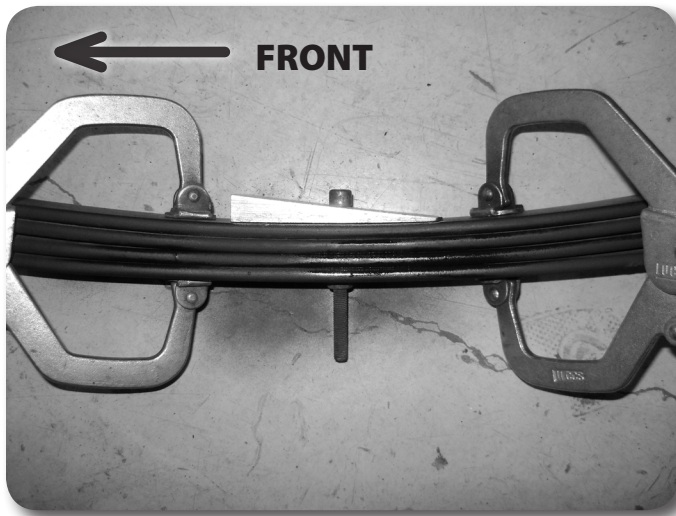

Figure 9

9. Install the new leaf spring to the frame and shackle mounts using the factory hardware. Leave hardware loose.
10. Lower the axle to the leaf spring and align the center pin/hole. Fasten the leaf springs to the axle with the provided new u-bolts. Fasten with the provided 1/2" high nuts and washers. Snug hardware just enough to loosely seat the spring. When lowering the axle make sure not to over-extend the brake line.
11. Repeat spring installation on opposite side of the vehicle.

12. With the rear spring installation complete, torque the u-bolts to 75-90 ft-lbs.
13. Located the provided 'Z' shaped brake line bracket. Attach to bracket to the hole in the bottom of the factory brake line mount on the frame **Figure 10** with the provided 3/8" hardware. Torque hardware to 30 ft-lbs. Install the brake line into the new bracket and fasten with the factory clip. Be sure the hardline is not rubbing on anything and is free of kinks.



Figure 10

14. Locate the new provided rear shocks. Install the provided bushings into the eyes. Install the provided sleeve into the BODY end bushing (which will mount to the axle). Install in the vehicle with the factory hardware. Torque the upper and lower hardware to 45 ft-lbs.
15. Install the wheels and lower the rear of the vehicle to the ground. Bounce the rear of the vehicle to help settle the suspension into place. Torque lug nuts to 75-90 ft-lbs.
16. Retorque the leaf spring u-bolts to 90 ft-lbs.
17. Torque the leaf spring shackle bolts to 75 ft-lbs, hanger bolts to 90 ft-lbs.

Post-Installation

1. Check all hardware for proper torque.
2. The steering wheel will need to be recentered after the lift is installed. This is done by loosening the clamps at each end of the steering drag links and rotating the adjusting link to center the wheel. With the front wheels straight, lengthen the drag link until the steering wheel is straight again. Take care to tighten the clamps securely when adjustment is complete.
3. Check hardware after 500 miles.

Post-Installation Warnings

1. Check all fasteners for proper torque. Check to ensure for adequate clearance between all rotating, mobile, fixed, and heated members. Verify clearance between exhaust and brake lines, fuel lines, fuel tank, floor boards and wiring harness. Check steering gear for clearance. Test and inspect brake system.
2. Perform steering sweep to ensure front brake hoses have adequate slack and do not contact any rotating, mobile or heated members. Inspect rear brake hoses at full extension for adequate slack. Failure to perform hose check/ replacement may result in component failure.
3. Perform head light check and adjustment.
4. Re-torque all fasteners after 500 miles. Always inspect fasteners and components during routine servicing.