



F1603 Installation Instructions 2008-10 Ford Super Duty F250/350 4wd 6" Radius Arm Suspension Lift

Read and understand all instructions and warnings prior to installation of product and operation of vehicle.

Zone Offroad Products recommends this system be installed by a professional technician. In addition to these instructions, professional knowledge of disassembly/ reassembly procedures and post installation checks must be known. Minimum tool requirements include the following: Assorted metric and standard wrenches, hammer, hydraulic floor jack and a set of jack stands. See the "Special Tools Required" section for additional tools needed to complete this installation properly and safely.

» PRODUCT SAFETY WARNING

Certain Zone Suspension Products are intended to improve off-road performance. Modifying your vehicle for off-road use may result in the vehicle handling differently than a factory equipped vehicle. Extreme care must be used to prevent loss of control or vehicle rollover. Failure to drive your modified vehicle safely may result in serious injury or death. Zone Offroad Products does not recommend the combined use of suspension lifts, body lifts, or other lifting devices.

You should never operate your modified vehicle under the influence of alcohol or drugs. Always drive your modified vehicle at reduced speeds to ensure your ability to control your vehicle under all driving conditions. Always wear your seat belt.

» TECHNICAL SUPPORT

Live Chat provides instant communication with Zone tech support. Anyone can access live chat through a link on www.zoneoffroad.com.

www.zoneoffroad.com may have additional information about this product including the latest instructions, videos, photos, etc.

Send an e-mail to tech@zoneoffroad.com detailing your issue for a quick response.

888.998.ZONE Call to speak directly with Zone tech support.

» PRE-INSTALLATION NOTES

1. Special literature required: OE Service Manual for model/year of vehicle. Refer to manual for proper disassembly/reassembly procedures of OE and related components.
2. Adhere to recommendations when replacement fasteners, retainers and keepers are called out in the OE manual.
3. Larger rim and tire combinations may increase leverage on suspension, steering, and related components. When selecting combinations larger than OE, consider the additional stress you could be inducing on the OE and related components.
4. Post suspension system vehicles may experience drive line vibrations. Angles may require tuning, slider on shaft may require replacement, shafts may need to be lengthened or trued, and U-joints may need to be replaced.
5. Secure and properly block vehicle prior to installation of Zone Offroad Products. Always wear safety glasses when using power tools.
6. If installation is to be performed without a hoist, Zone Offroad Products recommends rear alterations first.
7. Due to payload options and initial ride height variances, the amount of lift is a base figure. Final ride height dimensions may vary in accordance to original vehicle attitude. Always measure the attitude prior to beginning installation.

Difficulty Level

easy 1 2 **3** 4 5 difficult

Estimated installation: 4-6 hours

Special Tools Required

30mm (1-3/16") Socket

46mm (1-13/16") Socket

Heavy Duty Floor Jack and Stands

Pitman Arm Puller

Tire/Wheel Fitment

Tire:

37 x 12.50

Wheel:

17x9, 4.5" backsparing

Kit Contents

***Important* Verify you have all of the kit components before beginning installation.**

F1601 Radius Arm Box Kits (qty. 2)

Qty	Part	Qty	Part
2	Radius Arm	1	Stabilizer Bracket
4	Radius Arm Cam	1	Stabilizer Spacer
2	M18 x 2.5 Prevailing Torq Nut	1	Bolt Pack - Stabilizer
4	3/4 SAE Flat Washer	2	1/2"-13 x 1-1/4" bolt
2	1.00 x .120 x 3.25 DOM Sleeve	2	1/2"-13 prevailing torque nut
4	Radius Arm Bushing	6	1/2" SAE flat washer
2	1/4in - 28 Grease Zerk	1	12mm-1.75 x 80mm bolt
4	Mountable Zip Tie	1	12mm-1.75 prevailing torque nut
2	M18-2.5 x 150 Class 10.9 Bolt	2	Zip Tie
		4	Mountable Zip Tie

F1603 Box Kit

Qty	Part
1	1/8" Cotter Pin
1	Track Bar Bracket
2	Cam Washer
1	Sway Bar Drop Bracket (drv)
1	Sway Bar Drop Bracket (pass)
1	Bolt Pack - Sway Bar Drop
4	3/8"-16 x 1-1/4" bolt
4	3/8"-16 prevailing torque nut
8	3/8" USS flat washer
2	Bump Stop Spacer
2	8mm-1.25 x 130mm bolt
2	5/16" SAE washer
2	Hard Line Extension
2	Brake Line Brkt
1	Pitman Arm

F1613 Or F1623 Box Kit

Qty	Part
2	Coil Spring

F1308 or F1309 Rear Box Kit

Qty	Part
2	5in Block w/Single Pin & Bump Stop
2	11 SD Spr Plate
4	3/4-10 x 3-5/8 x 18-1/2 Ubolt (F1308 only)
4	3/4-10 x 3-5/8 x 15 Ubolt (F1309 only)
8	3/4"-10 Serrated Flange Nut

F6209 Rear Box Kit

Qty	Part
2	Short Add-A-Leaf
2	Long Add-A-Leaf
2	3" Clip/Clamp
2	7/16" x 6" Center Pin and Nut

Important—measure before starting!

Measure from the center of the wheel up to the bottom edge of the wheel opening

LF _____ RF _____

LR _____ RR _____

INSTALLATION INSTRUCTION

»» PRE-INSTALLATION NOTES

1. These vehicles, especially diesel models, are very heavy. Be sure that proper jacks/stands are used that are rated to handle the weight of the vehicle. Ensure that the vehicle is well supported before beginning the installation.
2. The factory front track bar bolt requires 405 ft-lbs of torque to be installed properly. Be sure you have the means of removing and installing this hardware properly. It is possible to install the hardware and torque to a more modest range (200 ft-lbs or so) and take the vehicle to a shop with the means to torque the hardware properly immediately after the installation is complete.
3. As a result of the location of the long radius arm suspension, support locations are limited. Use your best judgment while supporting the vehicle with sufficient strength stands at appropriate locations. The radius arms will need to move freely during this installation.

»» FRONT INSTALLATION

1. Park the vehicle on a clean, flat surface and block the rear wheels for safety.

2. Raise the front of the vehicle and support with jack stands under the frame rails - See Pre-Installation Note 3.
3. Remove the front wheels.
4. Support the front axle with a hydraulic jack.
5. Disconnect the track bar from the driver's side frame mount. Save hardware.

Figure 1

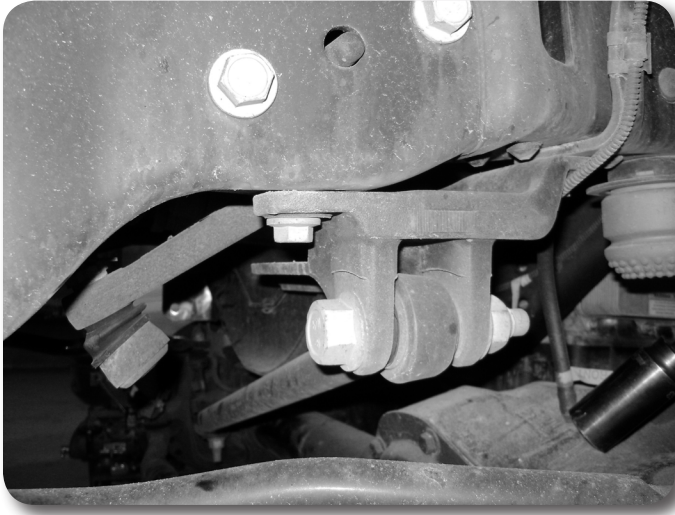

Figure 1

6. Disconnect the front brake line brackets from the axle and frame. Figure 2A-B. Save hardware.

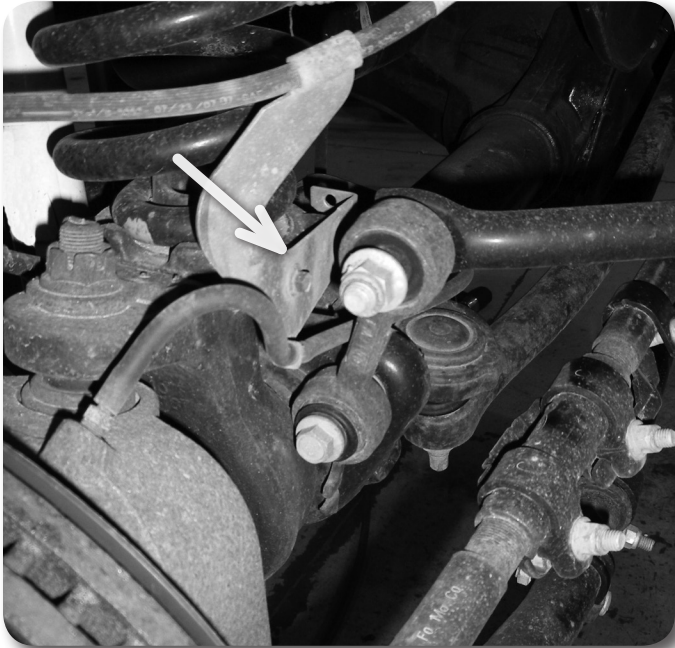

Figure 2A



Figure 2B

7. Remove the front axle hub vacuum lines retaining clips from the axle/radius arm. Figure 3A,B

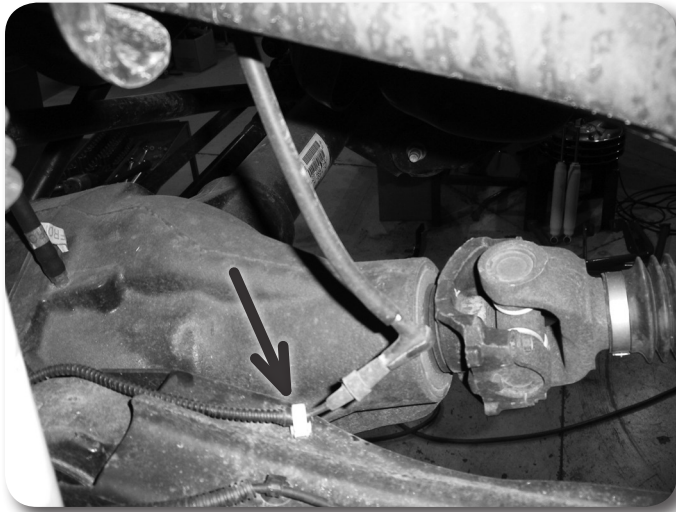

Figure 3A



Figure 3B

8. Remove the ABS brake lines from the retaining tabs on the radius arms.
Figure 6A/B

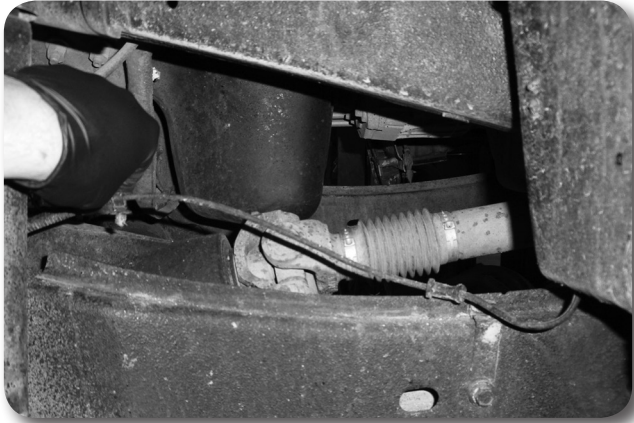

Figure 4A



Figure 4B

9. Disconnect the factory steering stabilizer from the frame bracket. The factory bracket can be removed or remain on the frame.
10. Install the new stabilizer frame bracket to the back side of the frame crossmember using the 2 front holes towards the passenger side. Use the provided 1/2" hardware and torque to 55 ft-lbs. Figure 5



Figure 5

Step 10 Note
Hardware for the steering stabilizer bracket is located in bolt pack 657.

11. Disconnect the front sway bar from the frame. Swing the sway bar down and allow it to rest on the steering during the installation. Save frame mount hardware.
12. Disconnect the steering drag link from the pitman arm. Remove the cotter pin and castellated nut cap. Remove the nut and thread back on by hand a couple turns. Strike the end of the pitman arm near the drag link end to dislodge the taper from the pitman arm. **Figure 6** Remove the nut and the drag link from the pitman arm. Save all hardware.



Figure 6

13. Disconnect the (5) bolts mounting the OE track bar bracket to the frame. Remove bracket and retain hardware. **Figure 7**

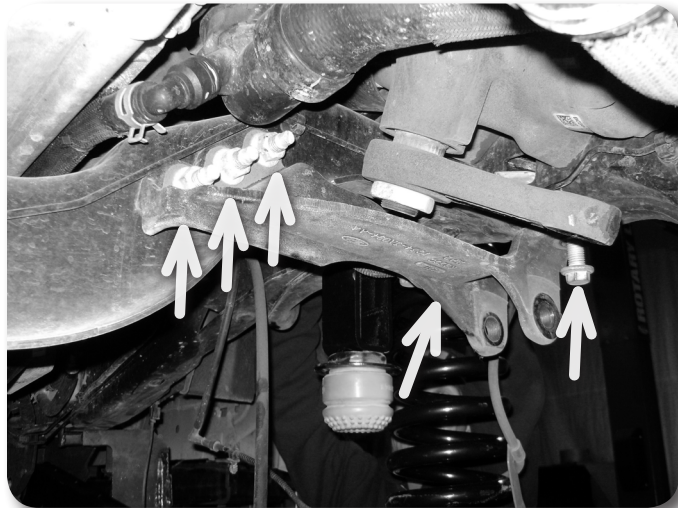

Figure 7

14. Remove the pitman arm nut. Note the indexing of the pitman arm in relation to the steering sector shaft and remove the pitman arm from the steering box using the appropriate puller.
15. Remove all of the dri-lock compound on the threads of the OE nut and steering sector shafts. This is important to ensure that the new thread lock compound will adhere properly.
16. Apply a bead of the supplied thread lock all the way around the threads of the OE nut and install the new pitman arm (indexed the same as the OE) and fasten with the OE nut. Torque the nut to 350 ft-lbs.

17. Install the new track bar bracket using the stock mounting hardware as it was removed. Torque all (5) mounting bolts to 129 ft-lbs. Do not install track bar at this time, it will be installed once the vehicle is on the ground. **Figure 8**



Figure 8

18. With the axle still well supported with a jack, disconnect the front shocks from the axle mounts. Leave the shocks attached to the frame, they will be used for added axle support during the next portion of the installation. Save axle hardware.
19. Carefully lower the axle and remove the factory front springs. Take care not to over-extend any lines/hoses. Save the upper spring isolator to be reinstalled with the new springs.
20. Reconnect the shocks to the axle with the original hardware. The shocks will help support the axle during the radius arm installation.
21. Remove the factory bump stops from the retainer cups on the frame. **Figure 9A**
Remove the bolt holding the retainer cup to the frame and remove from vehicle. **Figure 9B**



Figure 9A



Figure 9B

22. Reinstall the retainer cups on the frame along with the provided 4" tall bump stop spacers. Fasten with a provided 8mm x 130mm bolt and washer. **Figure 10** Apply Loctite to the bolt and torque to 15 ft-lbs. Be sure the flat lip of the retainer cup is oriented out toward the coil spring. Reinstall the factory bump stop into the retainer cup.



Figure 10

23. Locate and loosen the four radius arm mounting bolts at the axle. **Figure 11** Once again make sure that the axle is well supported by a jack.

Step 23 Note

On some models, the driver's side upper nut is welded to the radius arm.

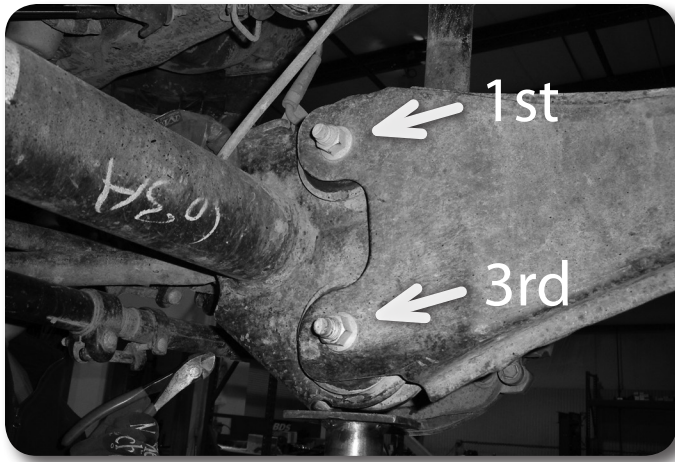

Figure 11

24. Starting with the passenger's side, 1st remove the upper radius arm mounting bolt at the axle. 2nd, remove the radius arm bolt at the frame and lower the radius arm from the frame bracket. 3rd, remove the lower mounting bolt at the axle and remove the radius arm from the vehicle. Figure 12 & 13 Save hardware.

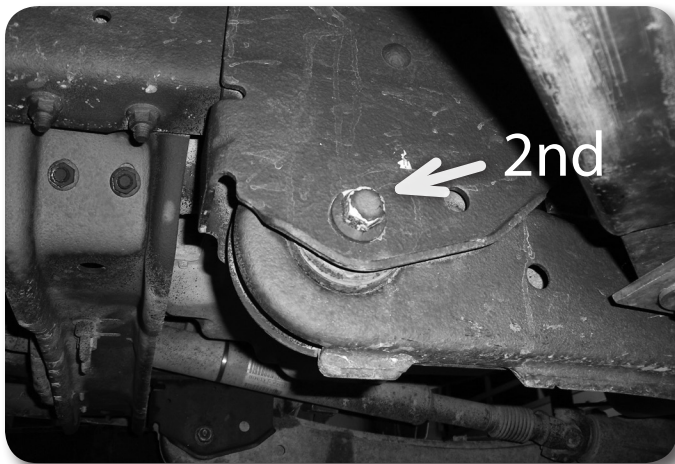

Figure 12

25. Locate the new radius arms, bushings, sleeves and grease fittings. Lightly grease and install the bushings and sleeves in each radius arm. Install the provided grease fittings into the thread hole and tighten securely. Figure 13



Figure 13

26. Install the new radius arm to the factory axle mounts. The end of the radius arm with the cam tabs goes to the bottom axle mount. **Figure 14A**. Loosely fasten the radius arm with the factory hardware. At the lower mount, install the provided rectangle cam plates on the new 18mm x 150mm bolt with a 3/4" SAE flat washer. The cam should be installed so the bolt is forward in the slot. **Figure 14B** Leave hardware loose.

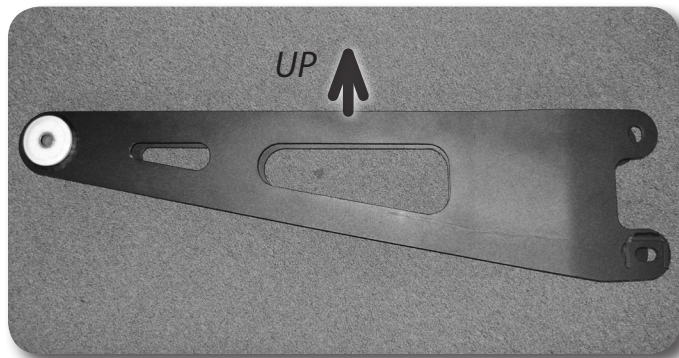

Figure 14A



Figure 14B

27. If possible, attach the the new radius arm to the factory frame mount. It may be necessary to remove the driver's side radius arm first before attaching the passenger's side. Use the factory hardware and leave loose at this time.
28. Repeat install procedure on the driver's side. On some models, the upper mount on the driver's side factory radius arm will have a captive nut. If this is the case, use one of the left-over lower factory nuts. Use the provided 18mm nut and 3/4" SAE flat washer on the new 18mm bolt along with the provided cam washers.
29. With the axle still well supported, disconnect the shocks from the axle and frame. Save the axle mount hardware.
30. Lower the axle just enough to install the new coil springs along with the factory upper rubber isolator. Once installed, rotate the coil so it seats properly in the axle mount. Raise the axle until the coil is seated in the upper mount.
31. Locate the new front shocks, bushings and sleeves. Install the bushings and sleeves into the shock eyes. Install the shocks using the factory lower hardware and provided stem hardware.

32. Locate the new sway bar drop brackets. Install the brackets on the frame with the original sway bar mount hardware. When installed the brackets should offset toward the front of the vehicle and the open face point to the inside. **Figure 15** Leave hardware loose.

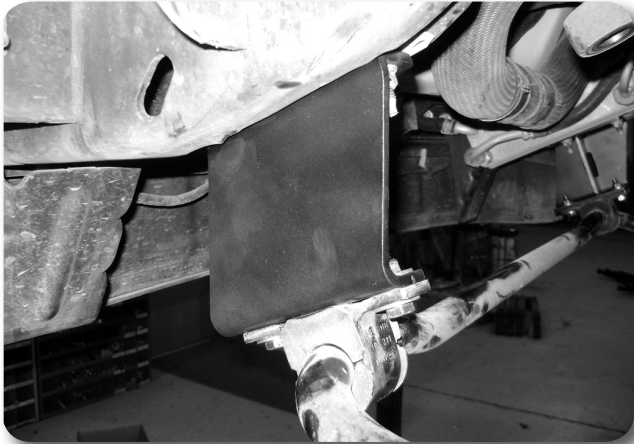

Figure 15

33. Attach the sway bar to the new drop brackets with the provided 3/8" hardware. Torque the factory hardware and new 3/8" hardware to 30 ft-lbs.
34. Attach the ABS wires to the new radius arms using the provided mountable zip ties installed into the small holes located in the top of the radius arms. **Figure 16** Tighten securely and cut off excess zip tie material.

Step 33 Note

Sway bar drop hardware is located in hardware pack #422

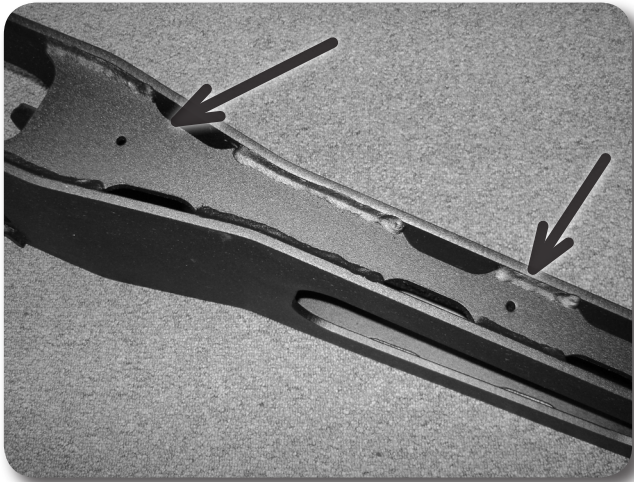

Figure 16

35. Reattach all vacuum lines. Use the provided zip ties where needed.
36. Located the new 'L' shaped brake line drop brackets. Install the brackets to the original brake line mount position on the frame. **Figure 17** Use the original brake line hardware and torque to 15 ft-lbs.

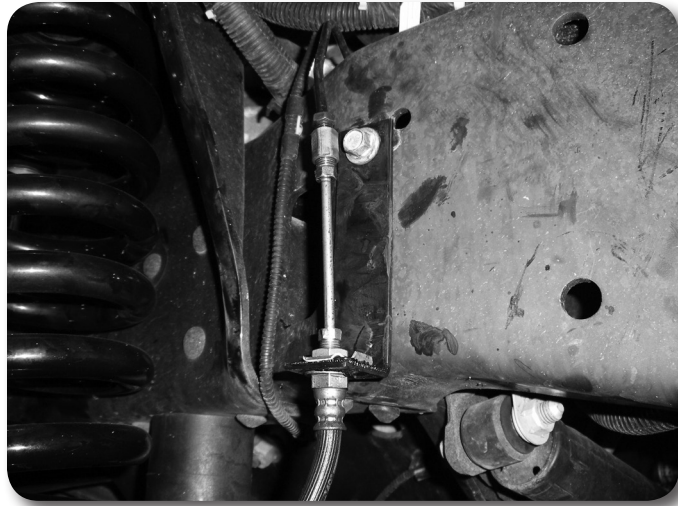

Figure 17

37. Separate the factory rubber brake line from the hard line. Install the provided hard line extension on the factory hard line and tighten the fitting securely.
38. Remove the brake line clip and factory brake line bracket from the rubber line. Save the clip and discard the bracket.
39. Run the end of the rubber line through the new bracket and attach to the hard line extension. Tighten the fitting securely and fasten the line to the bracket with the factory clip. Reconnect the brake line axle bracket.
40. Properly bleed the brake system of air and top off the brake fluid reservoir with the proper type of fluid (see owners manual).
41. Reattach the steering drag link to the pitman arm. Torque nut to 148 ft-lbs. Install the original castellated nut cap and new 1/8" cotter pin. **Figure 18**
42. Install the factory steering stabilizer below the new frame mount with the provided 12mm hardware and 3/4" steel spacer. **Figure 18.**

Step 41 Note

New cotter pin is located in hardware pack #656.

Step 42 Note

Hardware for the steering stabilizer bracket is located in bolt pack 657.



Figure 18

43. Install the front wheels and lower the vehicle to the ground. Torque lug nuts to 165 ft-lbs.
44. Bounce the front of the vehicle to settle the suspension. Torque all 6 radius arm bolts to 220 ft-lbs.

45. Install the factory track bar into the new frame bracket. Turn the steering wheel to aid in aligning the track bar in the bracket. Install the provided cam washers so that the hole is closer to the passenger side. **Figure 19** Fasten with the factory hardware and torque to 405 ft-lbs.



Figure 19

46. Check all hardware for proper torque.

» REAR INSTALLATION

1. Block the front wheels for safety.
2. Raise the rear of the vehicle and support with jack stands under the frame rails just ahead of the spring hangers.
3. Remove the wheels.
4. Support the axle with a hydraulic jack.
5. Remove the factory shocks. Retain all mounting hardware.
6. Disconnect the passenger's side spring u-bolts. Using two C-Clamps, clamp the leaf spring on each side of the top u-bolt plate. Remove the center pin nut and remove the u-bolt plate. **Figure 20**

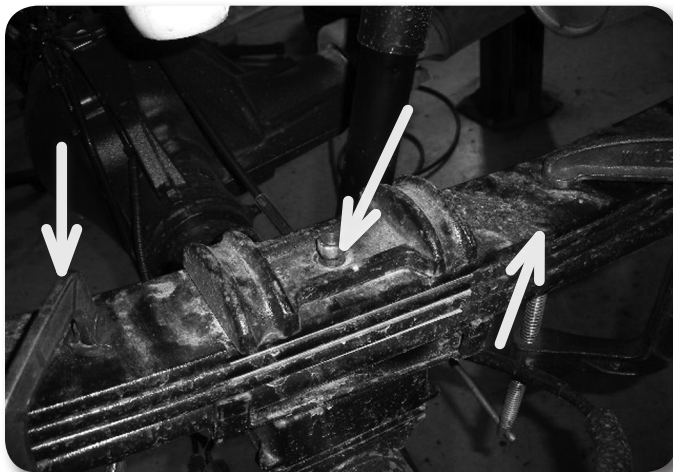

Figure 20

7. Remove the factory lift block. It will not be reused.
8. Cut off the front leaf alignment clamp for clearance w/ the new add-a-leaves.

Step 45 Note

See pre-installation note #2.

The track bar end should fit tight into the bracket. If necessary, use a heavy rubber dead-blow rubber hammer to help align the end into the bracket.

Step 7 Note

The factory rear block will vary depending on the vehicle model. F-250s will have a 1-7/8" block and F-350s will have a 3-3/4" block. In both cases, replacing the factory block with the new provided block will net the same level stance regardless of vehicle model.

9. Locate the supplied dual add-a-leafs and reassemble the leaf pack with the new add-a-leafs in place. The leaf pack should be assembled as a pyramid with the longest leaf on top to the shortest leaf on the bottom. Reinstall the center pin nut and torque to 40 ft-lbs. **Figure 21** The u-bolts, top plate and bottom plate will not be reused.

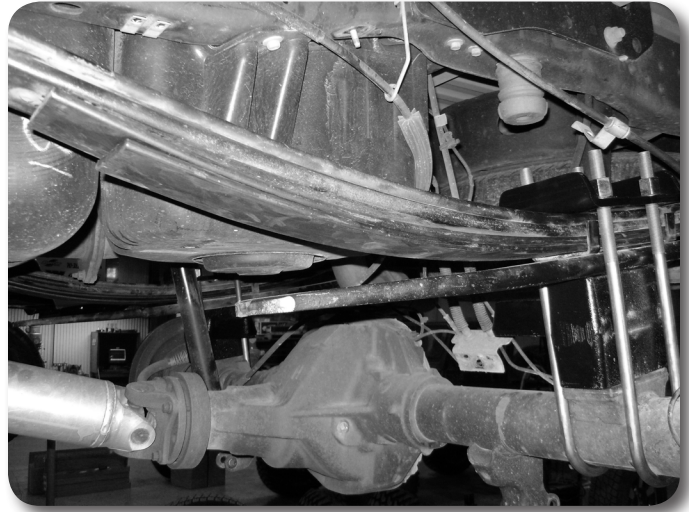

Figure 21

10. Remove the C-clamps from the leaf pack and ensure the individual leafs are all inline with each other. Install the provided bend-over style clamps on the front of the new leaf pack. Bend the ends of the clamps over to secure them to the spring.
11. Models equipped with overload leafs will need the separation block modified. Trim the rotation tabs from the front side of block on both the inside and outside of the block. Use extreme care near the fuel tank, do not use any method that will create sparks if the block is not removed when modified. A sawzall is highly recommended. **Figure 22**

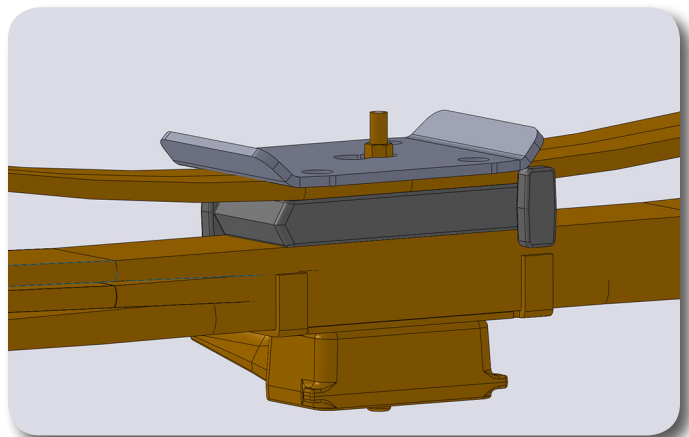

Figure 22

12. Lower the axle enough to place the provided 5" lift block between the axle and the leaf spring. Take care not to over extend the brake lines. Position the block so the bump stop wing faces inward. Make note that there are two center pin holes in the new blocks. The center pin will need to be aligned to the rear hole. This will ensure the axle moves slightly forward and the wheels are aligned properly in the wheel well.
13. Raise the axle to engage the block spring alignment pins. Be certain the leaf center pin aligns with the REAR hole in the new lift block. Position the new

u-bolt plate on the top of the spring over the center pin nut. Position the plate so the bolt pattern is shifted forward on the spring. **Figure 23** Fasten the entire assembly with the provided u-bolts, high nuts and washers. Snug but do not torque the u-bolts at this time.

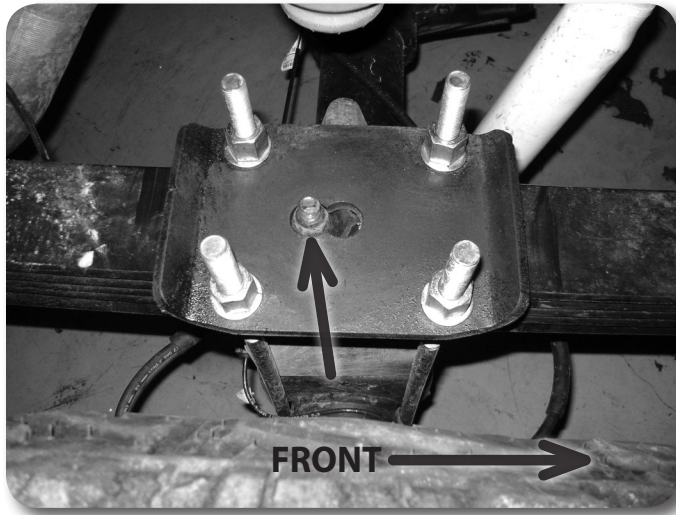

Figure 23

14. Repeat add-a-leaf and block installation of the driver's side. The parking brake cable bracket will need to be removed from the spring center pin. **Figure 24**



Figure 24

15. If more parking brake cable slack is needed, remove the cable from the rearmost retaining bracket on the frame. **Figure 25**



Figure 25

16. Install the new shocks with the original mounting hardware.
17. Install wheels and lower the vehicle to the ground.
18. With the weight of the vehicle on the axle, torque the u-bolts to 130-150 ft-lbs.

»» **POST INSTALLATION**

1. Check all hardware for proper torque. Check hardware after 500 miles.
2. Be sure the brake system has been properly bled and the brake fluid is topped off.
3. The steering wheel will need to be re-centered. This is done by adjusting the drag link collar near the passenger's side steering knuckle. Torque clamps to 41 ft-lbs. Thread the collar to lengthen the drag link.
4. Adjust headlights.

Post-Installation Warnings

1. Check all fasteners for proper torque. Check to ensure for adequate clearance between all rotating, mobile, fixed, and heated members. Verify clearance between exhaust and brake lines, fuel lines, fuel tank, floor boards and wiring harness. Check steering gear for clearance. Test and inspect brake system.
2. Perform steering sweep to ensure front brake hoses have adequate slack and do not contact any rotating, mobile or heated members. Inspect rear brake hoses at full extension for adequate slack. Failure to perform hose check/ replacement may result in component failure.
3. Perform head light check and adjustment.
4. Re-torque all fasteners after 500 miles. Always inspect fasteners and components during routine servicing.