



F2612 Installation Instructions 2009-2013 Ford F-150 4WD 4" & 6" Suspension System

Read and understand all instructions and warnings prior to installation of product and operation of vehicle.

Zone Offroad Products recommends this system be installed by a professional technician. In addition to these instructions, professional knowledge of disassembly/ reassembly procedures and post installation checks must be known. Minimum tool requirements include the following: Assorted metric and standard wrenches, hammer, hydraulic floor jack and a set of jack stands. See the "Special Tools Required" section for additional tools needed to complete this installation properly and safely.

» PRODUCT SAFETY WARNING

Certain Zone Suspension Products are intended to improve off-road performance. Modifying your vehicle for off-road use may result in the vehicle handling differently than a factory equipped vehicle. Extreme care must be used to prevent loss of control or vehicle rollover. Failure to drive your modified vehicle safely may result in serious injury or death. Zone Offroad Products does not recommend the combined use of suspension lifts, body lifts, or other lifting devices.

You should never operate your modified vehicle under the influence of alcohol or drugs. Always drive your modified vehicle at reduced speeds to ensure your ability to control your vehicle under all driving conditions. Always wear your seat belt.

» TECHNICAL SUPPORT

Live Chat provides instant communication with Zone tech support. Anyone can access live chat through a link on www.zoneoffroad.com.

www.zoneoffroad.com may have additional information about this product including the latest instructions, videos, photos, etc.

Send an e-mail to tech-zone@sporttruckusainc.com detailing your issue for a quick response.

888.998.ZONE Call to speak directly with Zone tech support.

» PRE-INSTALLATION NOTES

1. Special literature required: OE Service Manual for model/year of vehicle. Refer to manual for proper disassembly/reassembly procedures of OE and related components.
2. Adhere to recommendations when replacement fasteners, retainers and keepers are called out in the OE manual.
3. Larger rim and tire combinations may increase leverage on suspension, steering, and related components. When selecting combinations larger than OE, consider the additional stress you could be inducing on the OE and related components.
4. Post suspension system vehicles may experience drive line vibrations. Angles may require tuning, slider on shaft may require replacement, shafts may need to be lengthened or trued, and U-joints may need to be replaced.
5. Secure and properly block vehicle prior to installation of Zone Offroad Products. Always wear safety glasses when using power tools.
6. If installation is to be performed without a hoist, Zone Offroad Products recommends rear alterations first.
7. Due to payload options and initial ride height variances, the amount of lift is a base figure. Final ride height dimensions may vary in accordance to original vehicle attitude. Always measure the attitude prior to beginning installation.

Difficulty Level

easy 1 2 3 **4** 5 difficult

Estimated installation: 8-10 hours

Tire/Wheel Fitment

37x12.50x18 w/ 5" Backspacing

35x13.50x18 w/ 5" Backspacing

35x12.50x18 w/ 4.5" Backspacing

37x12.50x20 w/ 5-5.5" Backspacing

35x13.50x20 w/ 5-5.5" Backspacing

35x12.50x20 w/ 4.5" Backspacing

17" wheels will not fit after installation. Stock 20's can be reinstalled with stock tires only

Kit Contents

Qty	Part
1	Steering Knuckle (Drv)
1	Steering Knuckle (Pass)
1	Front Crossmember
1	Rear Crossmember
2	Sway Bar Drop / X-Member Brace
2	Differential Drop Bracket
1	Pass. Side Diff Brace
1	Diff Skid Plate
1	Front Driveshaft Spacer
1	Bolt Pack - Drive Shaft Spacer
1	Bolt Pack - Main Hardware
1	Bolt Pack - Sway Bar Mounting Hardware
2	Brake Line Drop Bracket
8	Cam Washer
2	Cam Bolt - 150mm
2	Bolt - 150mm
2	Cam Bolt - 180mm
6	18mm Cam Bolt Nut
4	3/4" USS Washer

» 5" REAR KIT

1	Offset Brake Line Drop Bracket
2	5" Offset Rear Block
1	E-brake Bracket
4	9/16" x 3-1/8" x 15" Square U-bolt
8	9/16" High Nut
8	9/16" SAE Washer
2	Lower Offset Center Pin Plate
2	Upper U-bolt Retaining Plate
1	Bolt Pack - Rear Block Kit
2	1/2" x 4" Center pin w/ nuts

» 4" REAR KIT

1	Offset Brake Line Drop Bracket
1	4" Offset Rear Block - DRV
1	4" Offset Rear Block - Pass
1	E-brake Bracket
4	9/16" x 3-1/8" x 15" Square U-bolt
8	9/16" High Nut
8	9/16" SAE Washer
1	Bolt pack - e-brake hardware
1	Bolt pack - front strut spacers
1	4" Strut spacer - DRV
1	4" Strut spacer - Pass

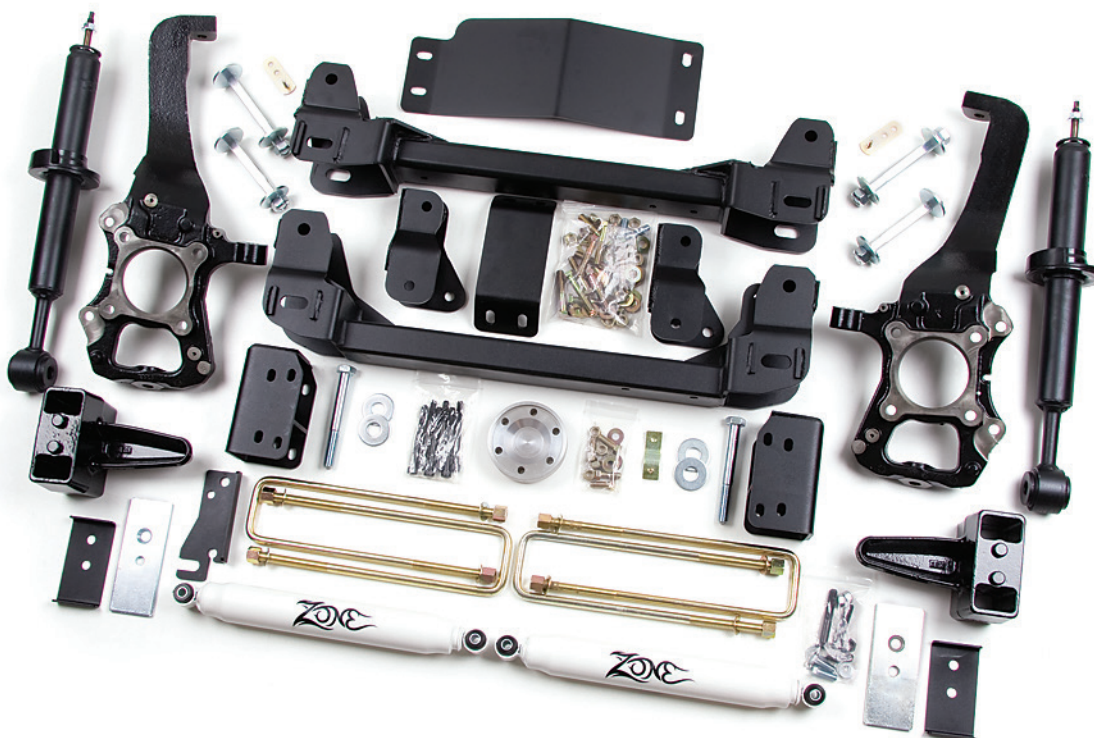

INSTALLATION INSTRUCTIONS

» FRONT INSTALLATION

1. Park the vehicle on a clean, flat surface and block the rear wheels for safety.
2. Measure from the center of the wheel up to the bottom edge of the wheel opening and record below:

LF _____ RF _____

LR _____ RR _____

3. Raise the front of the vehicle and support with jack stands at each frame rail behind the lower control arms.
4. Remove the front wheels.
5. 2011 and newer models equipped with EPAS (Electronic Power Assist Steering), disconnect the power steering control module connector to avoid arching of the contacts in the internal power relay from a hammer blow or impact wrench.
6. Remove the brake caliper anchor bracket bolts and remove the caliper from the knuckle **Figure 1**. Hang the caliper out of the way. Do not let the caliper hang by the brake hoses.
7. Disconnect the hub vacuum line from the hub. **Figure 1**



Figure 1

8. Remove the brake rotor and set aside.
9. Disconnect the ABS and hub vacuum lines from the retaining clips. Disconnect the brakeline bracket from the frame rail. Disconnect the ABS line from the inner fenderwell, and disconnect the clip **Figures 2 / 3**.

Important—measure before starting!

Measure from the center of the wheel up to the bottom edge of the wheel opening

LF _____ RF _____

LR _____ RR _____



Figure 2



Figure 3

10. Disconnect the tie rod ends from the steering knuckles [Figure 4](#). Remove and retain the mounting nuts. Strike the steering knuckle near the tie rod end to dislodge the end. Take care not to strike the tie rod end.



Figure 4

11. Disconnect the sway bar links from the sway bar **Figure 5**. Retain hardware. The sway bar links do not need to be removed from the lower control arms.

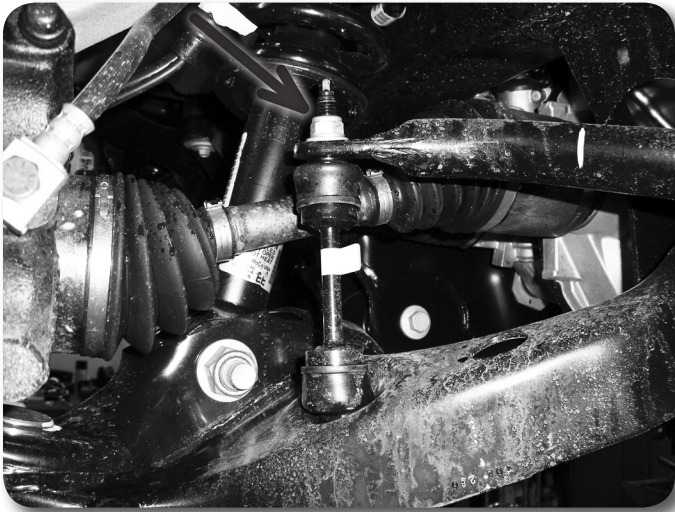

Figure 5

12. Remove the four sway bar mounting nuts and remove the sway bar from the vehicle **Figure 6**. Retain hardware.



Figure 6

13. Carefully remove the hub dust cap to expose the axle shaft nut Figures 7/8. Remove the nut. Retain the cap and nut, they will be reinstalled later.



Figure 7



Figure 8

14. Loosen but do not remove the three strut assembly mounting nuts at the frame **Figure 9**. Do not loosen the middle strut nut.

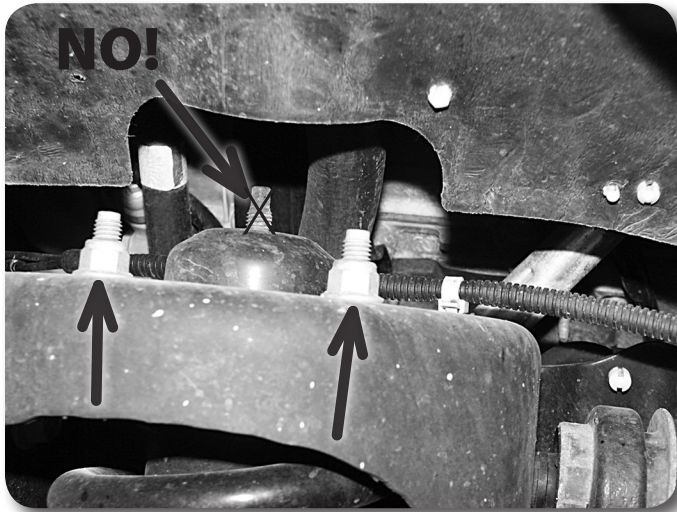

Figure 9

15. Loosen and remove the nut from the strut-to-lower control arm mounting bolt **Figure 10**. Leave the bolt in place at this time. Retain the mounting nut.

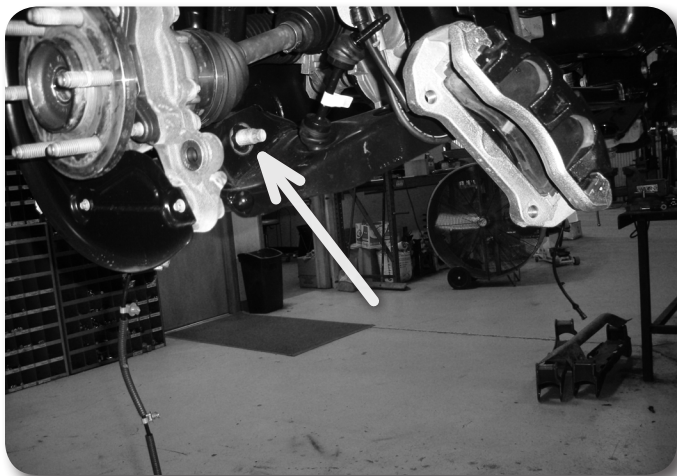

Figure 10

16. Remove the upper and lower ball joint nuts **Figure 11** and reinstall a few turns.

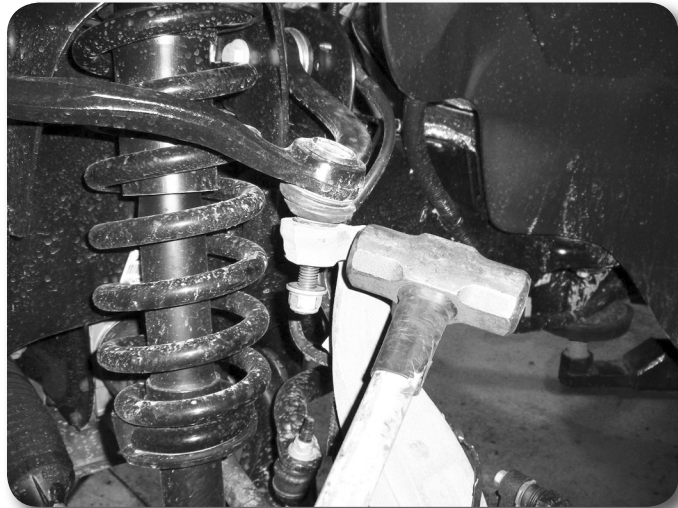

Figure 11

17. Strike the knuckle near the upper and lower ball joints to dislodge the joints from the knuckle.
18. Remove the upper ball joint and the strut-to-lower control arm bolt. Swing the knuckle/lower control arm down to remove the CV shaft from the hub. Retain ball joint nut and strut bolt.
19. Remove the lower ball joint nut and remove the knuckle from the vehicle. Retain hardware.
20. Remove the lower control arm mounting bolts and remove the lower control arm from the vehicle. Retain hardware.
21. Mark the struts to distinguish between driver's and passenger's. In addition, mark the relationship between the coil and the lower strut mounting hole and finally the top plate and the rubber coil seat.
22. Remove the three strut assembly mounting nuts at the frame and remove the strut assembly from the vehicle.
23. 2009 models only: Take a wire brush and remove the material from the threads of the four bolts that attach the OE rear crossmember. Spray threads with lubricant and remove the bolts and crossmember from the vehicle. Discard the crossmember and hardware. **Figure 12**

Step 23 Note:

2010 models do not require this step.



Figure 12

24. Remove the driveshaft mounting bolts and disconnect the driveshaft from the differential **Figure 13**. Allow the driveshaft to rest out of the way.



Figure 13

25. Remove the passenger's side CV shaft. Strike the shaft with a hammer to dislodge it from the splines. This will make handling the differential much easier. **Figure 14**



Figure 14

26. Support the front differential with an appropriate jack. Loosen all of the hardware and slide the differential all the way to the passenger's side. Orientate the joint at the steering rack so there is the most possible clearance to remove the front driver's side bolt. Remove this bolt first. Disconnect the differential breather hose from the differential housing. Remove the rear driver's side and one passenger's side differential mounting bolts **Figure 15 / 16 / 17** and remove the differential from the vehicle.

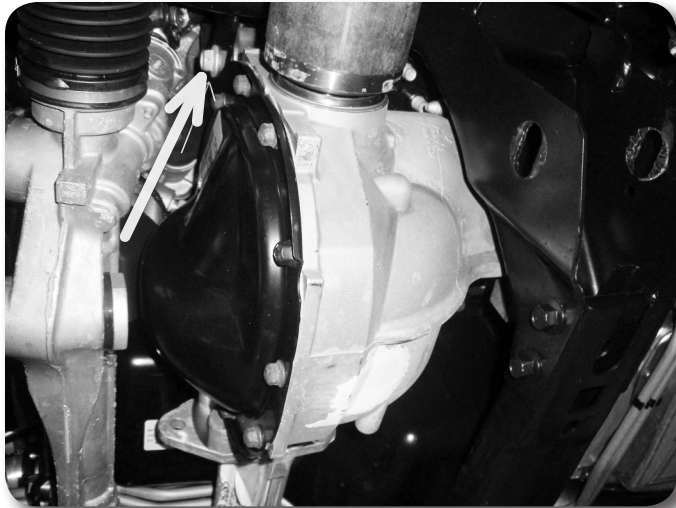

Figure 15

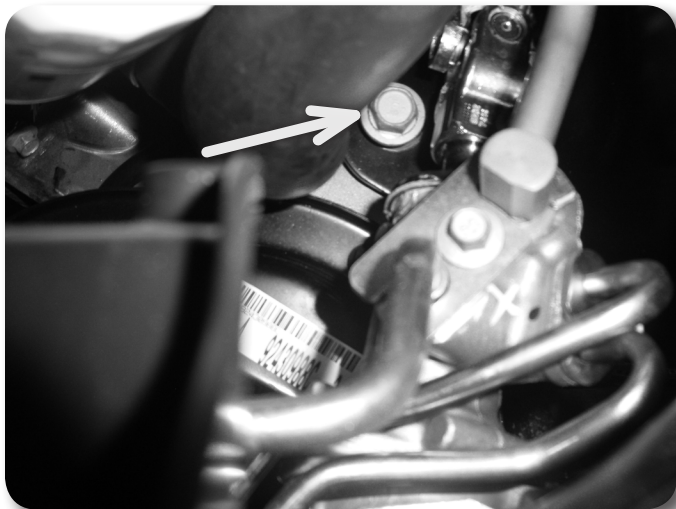

Figure 16

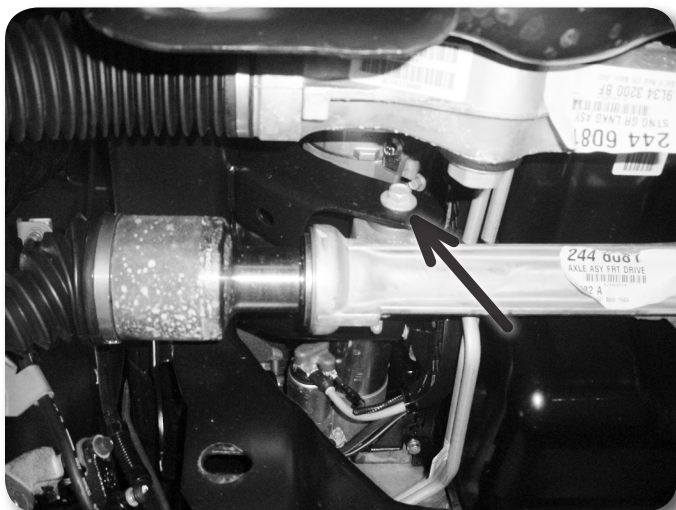

Figure 17

27. Pull down on the differential breather hose to gain additional slack.

28. The driver's side rear lower control arm frame pocket must be modified to provide clearance for the differential in its relocated position. On the front side measure from the inside edge of the factory control arm slot $5/8$ " Figure 18. Make a vertical cut line at the mark. Measure down $1-3/4$ " from the center of the slot, make a horizontal cut line.

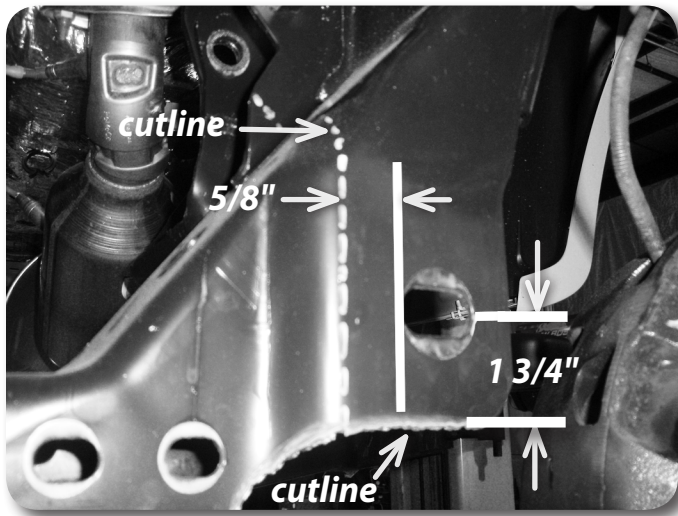

Figure 18

Figure 18 Note:

Measure in $5/8$ " from inside of slot edge.

Measure down $1-3/4$ " from the center of the slot and make a horizontal line.

29. On the back side measure from the outside edge of the control arm pocket $4-1/2$ " and mark Figure 19. Make a vertical cut line at the mark.

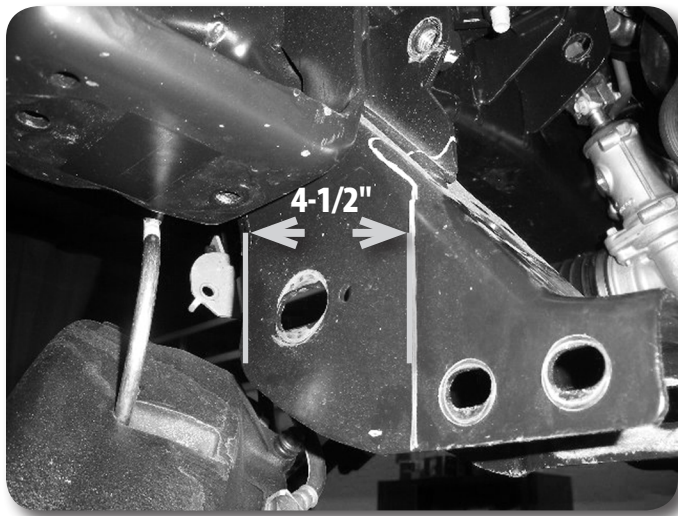

Figure 19

30. On the 'inside' face, measure up $3/4$ " from the bottom of the original diff mount bracket. Draw a horizontal line to the front and rear face. Figures 20
31. Trim the area from the vehicle.

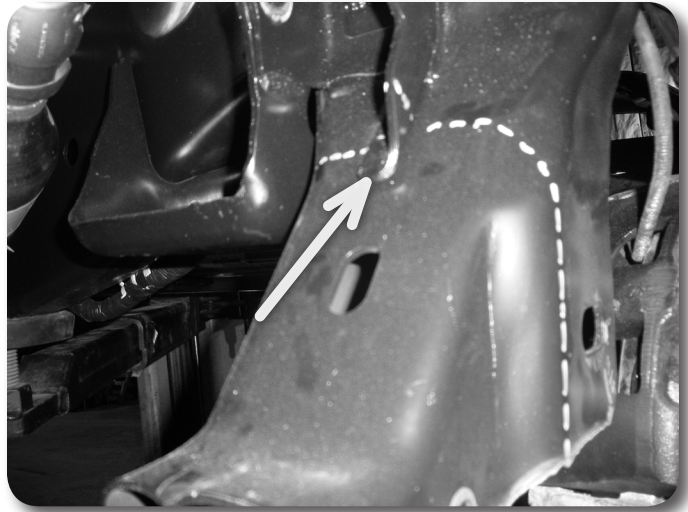

Figure 20

Figure 20 Note:

Measure up 3/4" from the edge as shown.

32. The passenger's side control arm pocket must also be trimmed. Measure down 1-3/4" and make a horizontal cut line. The cut will stop where the vertical offset begins, taper the cut as shown. Figure 21

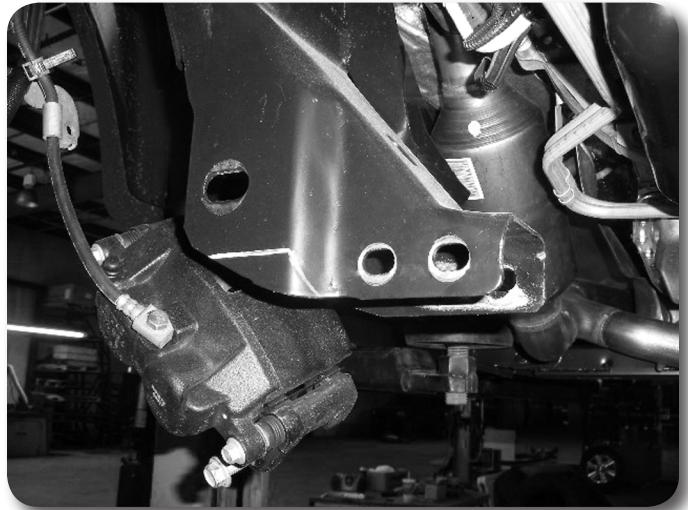

Figure 21

33. Install the rear crossmember Figure 22

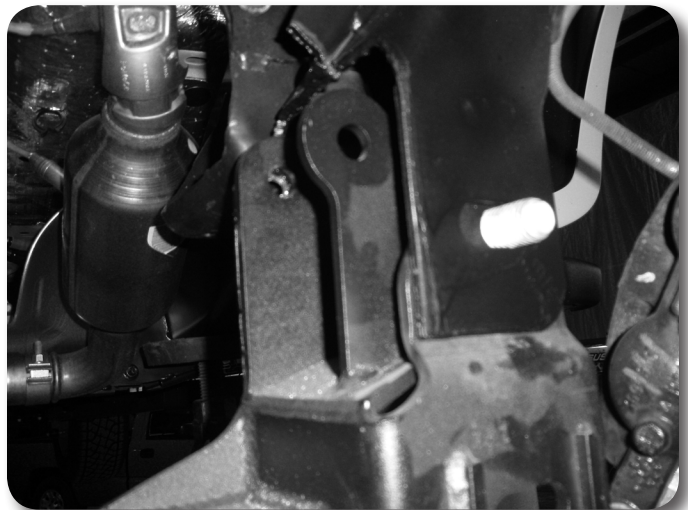

Figure 22

34. With the crossmember installed mark the differential hole on the factory control arm bracket. Remove the crossmember and drill a 5/8" hole at the mark, for easiest access drill the hole from front to back. **Figure 23**



Figure 23

35. Install the new differential drop brackets in the passenger's side and front driver's side factory differential mounting locations with the factory hardware. The brackets should offset toward the front of the vehicle when properly installed. On 2011 models w/ electric power steering: Install the bracket onto the differential first, run the hardware from front to rear for clearance to the steering rack.
36. Raise the differential in the vehicle by aligning the differential mounts in the two front drop brackets and in the rear crossmember. Install the passenger's side hardware from front - rear. Install the driver's side hardware from rear - front. **Figure 24**

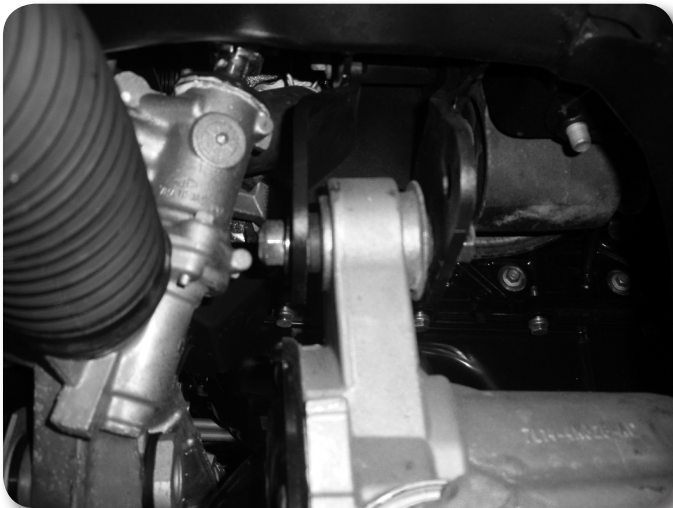

Figure 24

37. Install the new rear crossmember in the rear lower control arm frame pockets and fasten with new 18mm bolts and washers (do not put nuts on at this time). Run bolts from front to rear. Leave hardware loose. Ensure the hole that was drilled in the frame pocket lines up to the differential mounting hole in the bracket. **Figure 25**

Step 34 Note:

Drill hole from front to rear.

Step 36 Note:

Run driver's side front diff bolt from rear to front. The driver's side front bolt is 9/16" x 3-3/4". (BP# 781), 2011 model year trucks will need the hardware to run frt to rear

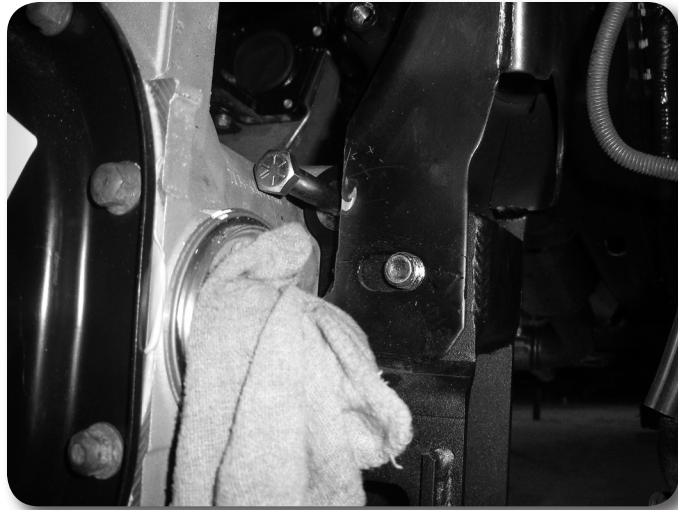

Figure 25

Figure 25 Note:

Run driver's side front diff bolt from front to rear. The driver's side rear bolt is 9/16" x4". (BP #781)

38. Fasten the differential to the rear crossmember **Figure 26** with a 9/16" bolt, washers, and nut. Run the bolt from front to rear. Leave hardware loose.

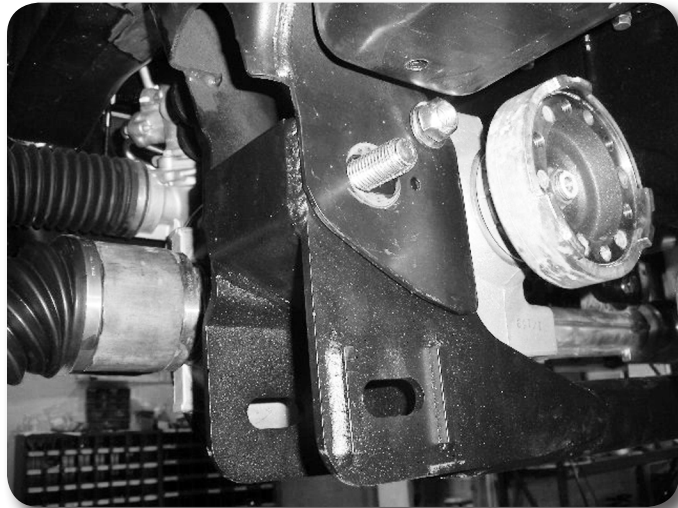

Figure 26

39. Install the offset differential support bracket to the passenger's side differential bracket using 9/16" hardware and 1/2" x 3" hardware to the crossmember. The horizontal slots will be located up at the differential. Leave hardware loose.

Figure 27

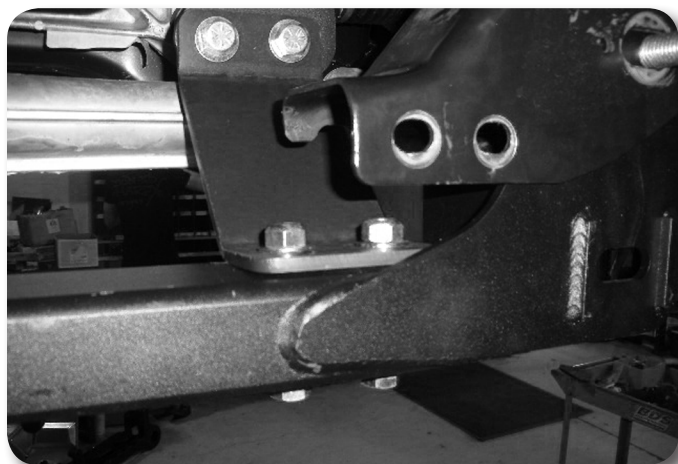

Figure 27

Figure 27 Note:

Passenger's side differential drop bracket hardware is located in BP #781.

40. Go back and torque all the differential mounting hardware (9/16" and 14mm) to 95 ft-lbs (6 bolts total). Attach the differential breather hose to the differential.
41. Install the front crossmember in the front lower control arm pockets and fasten with the OE lower control arm hardware. Leave hardware loose.
42. Install the lower control arms in the new crossmembers and fasten with the provided 18mm cam bolts, cam washers and 18mm nuts. Run the front bolts from front to rear and leave loose. Run the rear bolts from rear to front. The main body of the cam will be 'up' in the cam slot
43. Install the provided differential skid plate to the front and rear crossmembers with 1/2" x 1-1/4" bolts and 1/2" SAE washers into the threaded holes in the crossmembers **Figure 28**. Leave hardware loose.



Figure 28

Figure 28 Note:

1/2" x 1-1/4" bolts with washers - use loc-tite on threads. (BP #781)

44. Install the sway bar drop brackets with new 3/8" x 1-1/4" hardware, snug but do not tighten at this time. Attach the crossmember 18mm nut with 3/4" USS washer. Note: Use a ratchet extension through the lower slots to access the hardware **Figures 29**



Figure 29

Figure 29 Note:

Install 3/8" x 1-1/4" hardware into sway bar drop brackets. (BP #781)
Run the bolts from bottom - up.

45. With the lower control arms installed, go back and torque the four crossmember mounting bolts to 222 ft-lbs. Ensure that the front crossmember is centered in the vehicle. Torque the differential skid plate bolts to 65 ft-lbs. Tighten sway bar drop hardware to 35 ft-lbs.

46. For 6" kits, follow steps 46-51, 4" kits, skip ahead to step #52.
47. Place the strut assembly into a high quality spring compressor. Only use a high quality wall mounted spring compressor! **Figure 30**



Figure 30

48. Compress the coil following spring compressor instructions and remove the strut nut.
49. Remove the top cap and upper spring isolator.
50. Install the new lower coil seat and bump stop onto replacement strut.
51. Align marks on coil to the upper mount and also with the lower mounting hole. Install the new strut in the coil spring and factory top cap. Fasten the strut rod with the new provided 12mm flange nut. Torque strut rod nut to 40 ft-lbs.
52. Install the strut assemblies in the appropriate sides on the vehicle with factory hardware, leave hardware loose at this time. Skip ahead to step #54
53. **4" kit only:** Place the upper strut spacers on top of the factory struts with factory hardware. The strut spacers are labeled, install part # 02427 onto the driver's side and #02428 onto the passenger's side. Tighten the factory nuts to 40 ft-lbs. Fig 30b

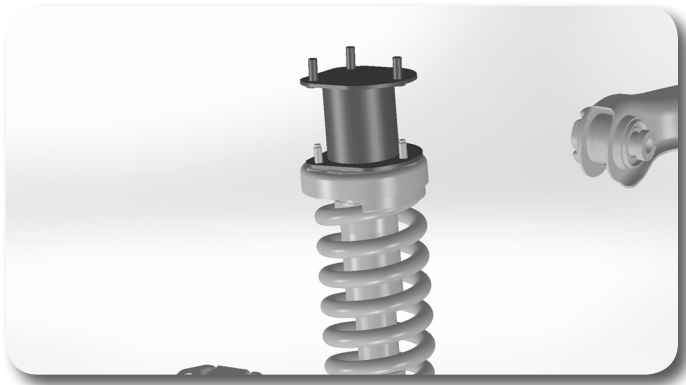

Figure 30B - 4" Kit only

54. Install the strut assembly with new 7/16" nuts and washers on top of the frame strut mount. Attach lower strut mount to the control arm with the factory bolt. Leave all hardware loose at this time.
55. Reinstall the passengers side CV.
56. Remove the four hub bolts from the knuckle and remove the hub from the knuckle **Figure 31**. Inspect mounting surface of the hub assembly and clean any dirt or corrosion off as necessary.

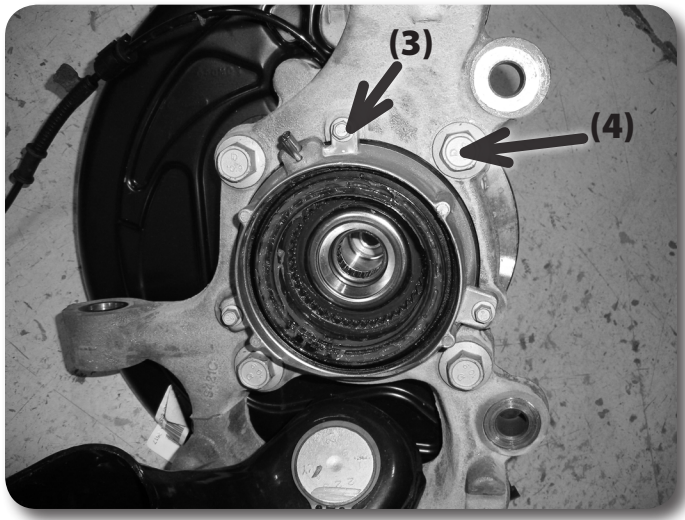

Figure 31

57. Install the hub into the corresponding new knuckle and fasten with the factory bolts. The ABS wire will be located at the 'top' of the hub. Use Loctite on the bolt threads and torque to 148 ft-lbs.
58. Remove the three 6mm bolts mounting the vacuum hub assembly to the inside of the factory knuckle **Figure 32**. Transfer the vacuum assembly over to the new knuckle. Make sure the vacuum port is pointing towards the top. Attach with the factory bolts, tighten bolts securely (about 5-7 ft-lbs).

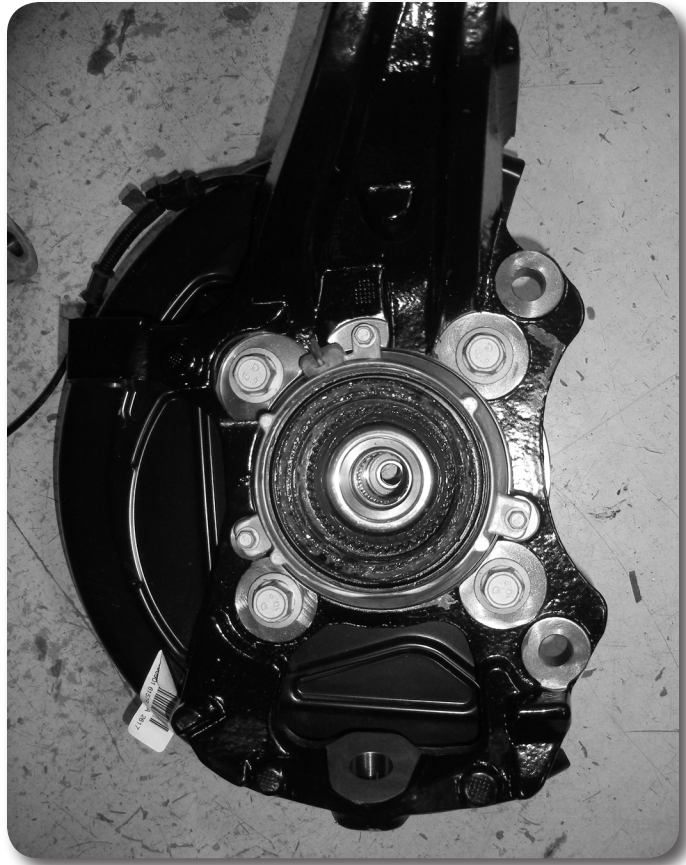

Figure 32

59. Install the dust shield with the factory 6mm bolts, tighten bolts securely (about 5-7 ft-lbs). Route the ABS cable behind the dust shield.
60. Install the new knuckle assembly on the lower control arm ball joint and loosely fasten with the original nut. Install the CV shaft in the hub, swing the whole assembly up and attach the lower control arm to the strut with the original hardware. Leave all hardware loose.
61. Attach the upper control arm to the knuckle with the original nut. Torque the upper ball joint to 85 ft-lbs and the lower ball joint to 111 ft-lbs. **Figure 33**

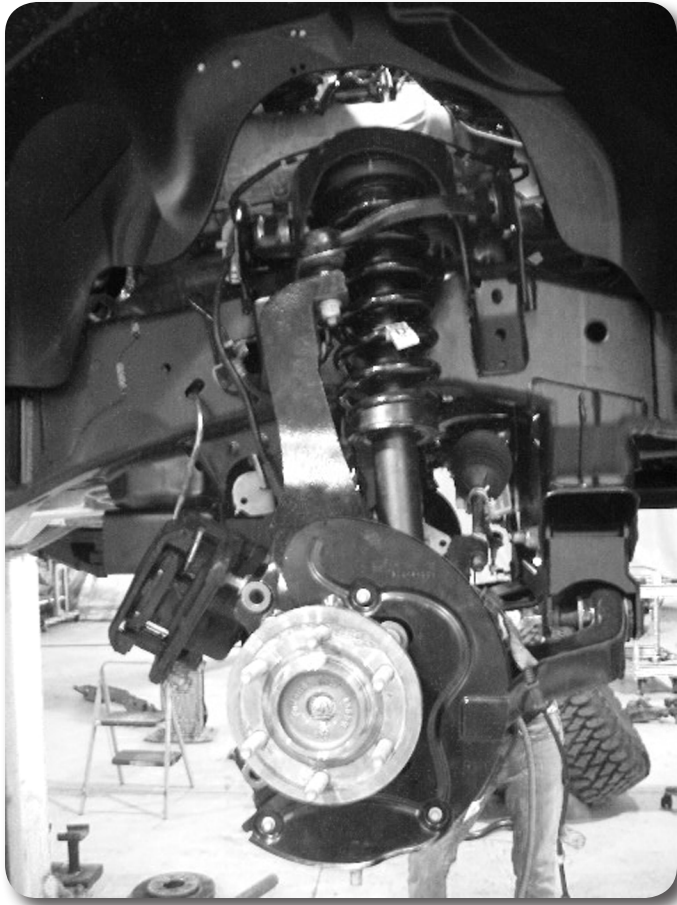

Figure 33

62. Torque the upper strut nuts to 35 ft-lbs. The lower bolt will be tightened later with the weight of the vehicle on the suspension.
63. Fasten the CV shaft to the hub with the original nut. Make sure the splines are engaged properly in the vacuum actuated section of the hub. The hub should have a very minor amount of rotational play with the CV shaft if installed properly, torque to 20 ft-lbs. Reinstall the dust cap.
64. Install tie rod from top-down. Torque to 111 ft-lbs.
65. Install the brake rotor and caliper to the knuckle with OE bolts. Torque to 148 ft-lbs.
66. Install the brake line relocation brackets at the frame. Attach with factory hardware to frame, attach brakeline retaining clip with 1/4" nut and washer to the relocation bracket. Tighten to 15 ft-lbs. Figures 34



Figure 34

Figure 34 Note:

1/4" nut and washer. (BP #781)

67. Attach the ABS line to the connector at the inner fender and the vacuum line to the hub. Route the lines similar to the factory setup down to the side of the knuckle. Attach the ABS wire with the factory 6mm bolt to the side of the knuckle. Attach the brakeline with a new 6mm x 18mm bolt with 1/4" washer to the side of the knuckle, the brakeline locating tab will go into the unthreaded hole. Figures 35

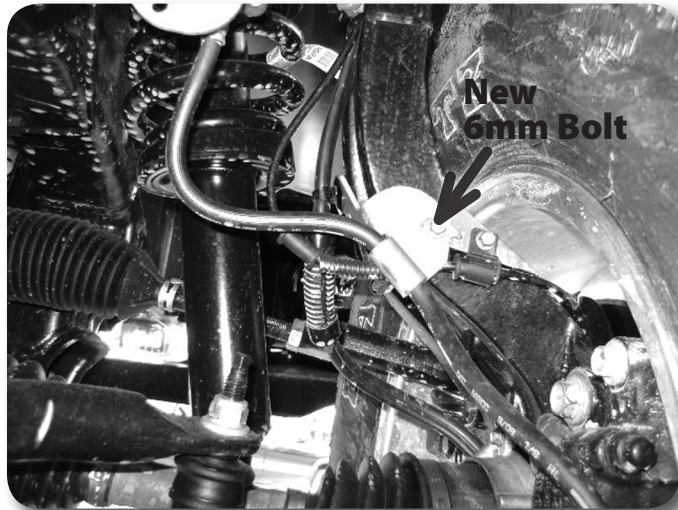

Figure 35

Figure 35 Note:

New 6mm bolt and washer (BP #781) is used to attach the metal brakeline bracket to the steering knuckle.

Step 68 Note:

Sway bar mounting hardware is in BP #407

68. Install the sway bar to the new sway bar drop brackets with 7/16" x 1-1/4" hardware. Attach the sway bar to the sway bar end links with the original hardware. Torque the 7/16" hardware to 45 ft-lbs. Torque sway bar link nut to 45 ft-lbs.
69. Install the supplied driveshaft spacer and reattach front driveshaft to differential with new hardware. Torque bolts to 76 ft-lbs. Figure 36

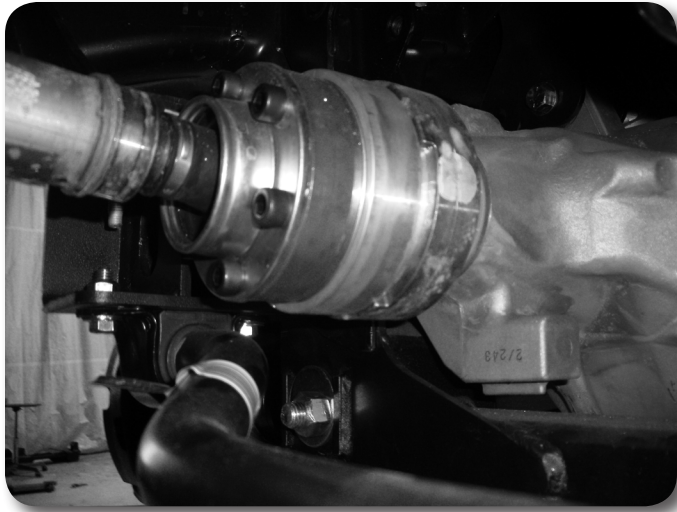

Figure 36

Figure 36 Note:

10mm allen head bolts located in BP #925 - use loc-tite on threads

70. Install the wheels and lower the vehicle to the ground.
71. Bounce the front of the vehicle to settle the suspension. Torque the lower strut mount bolt to 350 ft-lbs. Center the lower control arm cams and torque to 150 ft-lbs. tighten upper strut mounting hardware on replacement strut kits to 35 ft-lbs. Adjust the toe before driving it to an alignment shop.
72. Check all hardware for proper torque.

» **REAR INSTALLATION**

73. Block the front wheels and raise the rear of the vehicle. Place jack stands under the frame rails ahead of the spring hangers.
74. Remove the wheels.
75. The parking brake cable must be relocated. To disconnect the cable from the frame first pull down on the cable and clamp it off with vise grips near the middle of the frame **Figure 37**. This will gain slack to disconnect the driver's side rear cable from the main (passenger's side) cable.



Figure 37

76. Remove the driver's side parking brake cable from the junction bracket.
Figure 38



Figure 38

77. Compress the retaining tabs and remove the driver's side cable from the spring hanger Figure 39. It will be relocated and reconnected later.

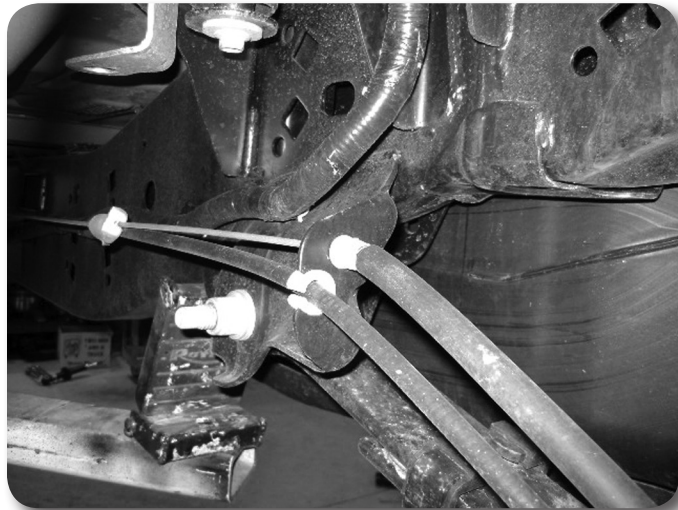

Figure 39

78. Disconnect the rear brake line from the frame. Figure 40

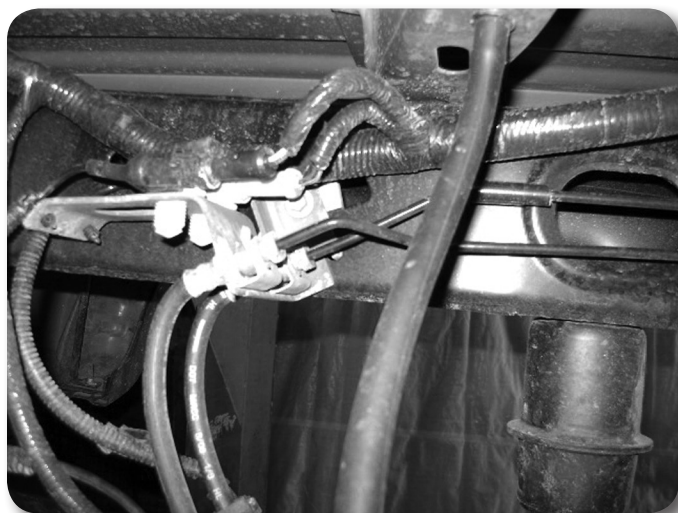

Figure 40

79. Support the rear axle with a hydraulic jack. Remove the factory shocks. Retain mounting hardware.
80. Note: Perform the rear installation on one side at a time.
81. Remove the passenger's side u-bolts.
82. Lower the axle and remove the factory lift block, it will not be reused.
83. For 5" rear block kits follow steps 83-86. 4" kits, skip ahead to step #87
84. Using C-clamps, clamp the leaf spring pack together on each side of the center pins. Remove the center pins and discard.
85. Place the plate on the bottom of the leaf pack and secure with new center pin in the 'forward' hole and flat head allen bolt through the 'rear' hole. Install new u-bolt retaining plate on top, it will be offset 'forward'. Tighten to 35 ft-lbs.

Figures 41 / 42 / 43

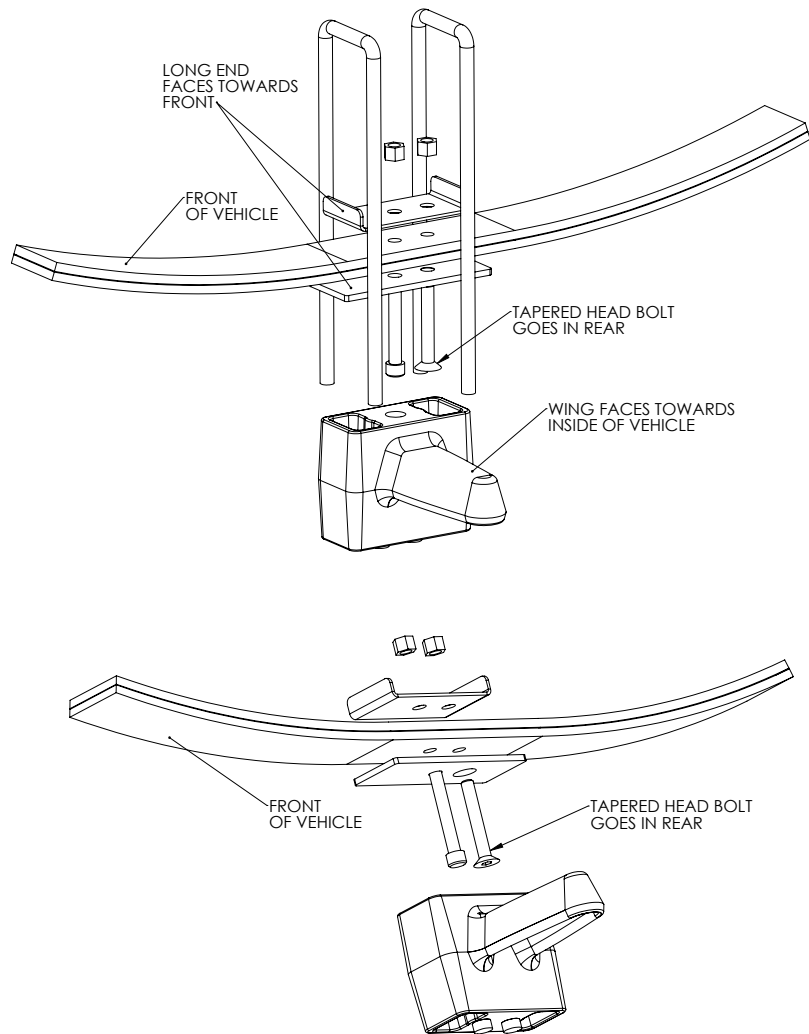

Figure 41

Figure 41 Note:

Flat head allen bolt is located in BP #774.



Figure 42

Figure 42 Note:

Trim excess from centerpin and flat head allen bolt.

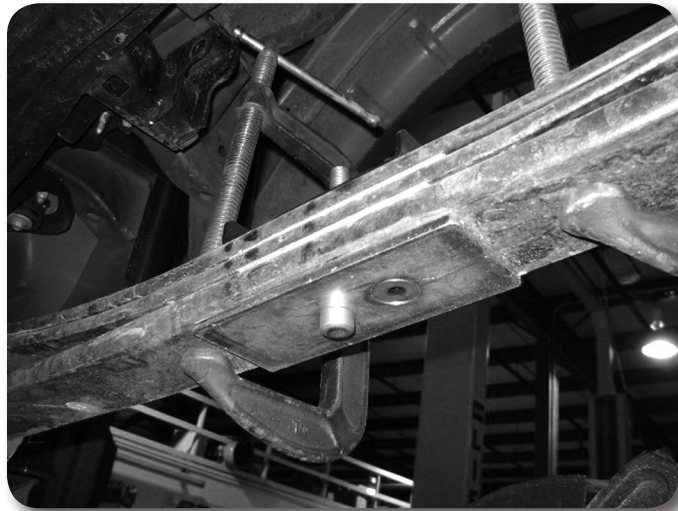

Figure 43

86. Install the new provided lift block so that the bump stop wing goes toward the inside of the vehicle. The block will use the both of the lower center pin holes. The upper only uses 1 hole which will shift the axle slightly forward.
87. Raise the axle/block to the spring while aligning the center pin. Fasten the spring/block assembly with the provided u-bolts, high nuts and washers. Snug u-bolts, they will be torque with the weight of the vehicle on the springs. **Figure 44**

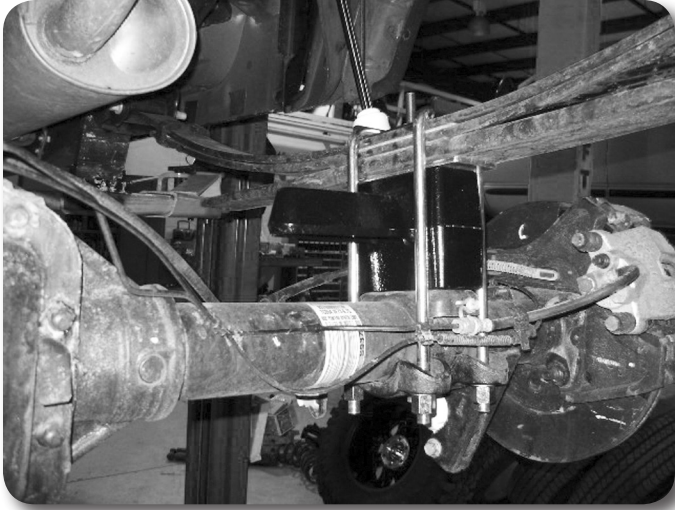

Figure 44

88. Install the new bump stop as shown (Fig 45). The gusset on the wing will face towards the front of the vehicle. The part # is stamped on the bump stop wing. Part # 02429 = Driver's side, #02430 = Pass side.

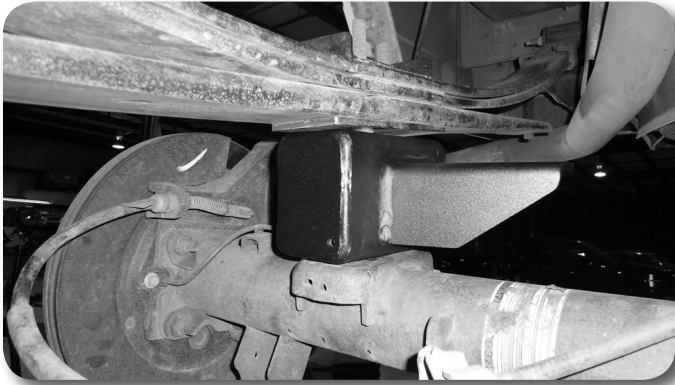

Figure 45

89. Raise the axle and align the center pins. Fasten the assembly with new u-bolts, high nuts, and washers. Snug - ubolts, do not tighten at this time. They will be tightened with the weight of the vehicle on the springs.
90. Repeat installation procedure on the driver's side of the vehicle.
91. Install the provided parking brake relocation bracket to the driver's side front spring hanger using 7/16" bolts, washers, and nuts. **Figure 46**
92. Reconnect the parking brake cable at the junction. When reconnected, remove the clamp to allow the cable to return to its normal tension. Attach the parking brake cable through the relocation bracket through the slot in the bottom. Models with Ford's electric retracting steps will need to order an extra relocation bracket, available separately. The steps can be temporarily disabled until the new bracket is installed. Feature is controlled in the instrument cluster computer.



Figure 46

93. Install the provided brake line relocation bracket to the driver's side frame rail with the factory brake line bracket bolt **Figure 47**. Torque to 15 ft-lbs.



Figure 47

Post-Installation Warnings

1. Check all fasteners for proper torque. Check to ensure for adequate clearance between all rotating, mobile, fixed, and heated members. Verify clearance between exhaust and brake lines, fuel lines, fuel tank, floor boards and wiring harness. Check steering gear for clearance. Test and inspect brake system.
2. Perform steering sweep to ensure front brake hoses have adequate slack and do not contact any rotating, mobile or heated members. Inspect rear brake hoses at full extension for adequate slack. Failure to perform hose check/ replacement may result in component failure.
3. Perform head light check and adjustment.
4. Re-torque all fasteners after 500 miles. Always inspect fasteners and components during routine servicing.

94. Attach the brake line to the relocation bracket with a 1/4" nut and 1/4" USS washer (BP #774). It may be necessary to rotate the OE brakeline clip bracket to have the lines face 'down' for adequate slack. Torque to 15 ft-lbs.
95. Install the new shocks with the OE hardware. Torque to 60 ft-lbs.
96. Check all lines/wires for proper slack.
97. If the vehicle is equipped with EPAS, reconnect the power steering control module connector.
98. Install the wheels and lower the vehicle to the ground.
99. Bounce the rear of the vehicle to settle the suspension.
100. Torque the u-bolts to 100-120 ft-lbs.
101. Check all hardware for proper torque
102. Check hardware after 500 miles.
103. A complete front end alignment is necessary.
104. Adjust headlights.